

# LIMBO: A Scalable Algorithm to Cluster Categorical Data

University of Toronto, Department of Computer Science

CSRG Technical Report 467

Periklis Andritsos    Panayiotis Tsaparas    Renée J. Miller    Kenneth C. Sevcik

{periklis,tsap,miller,kcs@cs.toronto.edu}

July 7, 2003

## Abstract

Clustering is a problem of great practical importance in numerous applications. The problem of clustering becomes more challenging when the data is categorical, that is, when there is no inherent distance measure between data values. In this work, we introduce LIMBO, a scalable hierarchical categorical clustering algorithm that builds on the *Information Bottleneck (IB)* framework for quantifying the relevant information preserved when clustering. We use the IB framework to define a distance measure for categorical tuples and we also present a novel distance measure for categorical attribute values. We show how the LIMBO algorithm can be used to cluster both tuples and attribute values. LIMBO handles large data sets by producing a summary model for the data. We propose two different versions of LIMBO, where we either control the size or the accuracy of the model. We present an experimental evaluation of both versions of LIMBO, and we study how clustering quality in information theoretic clustering algorithms compares to other categorical clustering algorithms. LIMBO also supports a tradeoff between efficiency (in terms of space and time). We quantify this trade-off and we demonstrate that LIMBO allows for substantial improvements in efficiency with negligible decrease in quality. LIMBO is a hierarchical algorithm that produces clusterings for a range of  $k$  values (where  $k$  is the number of clusters). We take advantage of this feature to examine heuristics for selecting good clusterings (with natural values of  $k$ ) within this range.

# 1 Introduction

Clustering is a problem of great practical importance that has been the focus of substantial research in several domains for decades. As storage capacities grow, we have at hand larger amounts of data available for analysis, and mining. Clustering plays an instrumental role in this process. This trend has created a surge of research activity in the construction of clustering algorithms that can handle large amounts of data, and produce results of high quality.

Clustering is defined as the problem of partitioning data objects into groups, such that objects in the same group are similar, while objects in different groups are dissimilar. This definition assumes that there is some well defined notion of *similarity*, or *distance* between data objects. When the objects are defined by a set of numerical attributes, there are natural definitions of distance based on geometric analogies. These definitions rely on the semantics of the data values themselves (for example, the values \$100,000 and \$110,000 are more similar than \$100,000 and \$1). The definition of distance allows us to define a *quality measure* for a clustering (*e.g.*, the mean square distance between each point and the centroid of its cluster). Clustering then becomes the problem of grouping together points such that the quality measure is optimized.

The problem of clustering becomes more challenging when the data is categorical, that is, when there is no inherent distance measure between data values. This is often the case in many domains, where data is described by a set of descriptive attributes, many of which are neither numerical nor inherently ordered in any way. As a concrete example, consider a relation that stores information about movies. For the purpose of exposition, a movie is a tuple characterized by the attributes “director”, “actor/actress”, and “genre”. An instance of this relation is shown in Table 1. In this setting it is not immediately obvious what the distance, or similarity, is between the values “Coppola” and “Scorsese”, or the tuples “Vertigo” and “Harvey”.

Without a clear measure of distance between data values, it is unclear how to define a quality measure for categorical clustering. To do this, we employ *mutual information*, a measure from information theory. A good clustering is one where the clusters are *informative* about the data objects they contain. Since data objects are expressed in terms of attribute values, we require that the clusters convey information about the attribute values of the objects in the cluster. That is, given a cluster, we wish to predict the attribute values associated with objects of the cluster accurately. The quality measure of the clustering is then the mutual information of the clusters and

the attribute values. Since a clustering is a summary of the data, some information is generally lost. Our objective will be to minimize this loss, or equivalently to minimize the increase in uncertainty as the objects are grouped into fewer and larger clusters.

	director	actor	genre	<b>C</b>	<b>D</b>
$t_1$ (Godfather II)	Scorsese	De Niro	Crime	$c_1$	$d_1$
$t_2$ (Good Fellas)	Coppola	De Niro	Crime	$c_1$	$d_1$
$t_3$ (Vertigo)	Hitchcock	Stewart	Thriller	$c_2$	$d_1$
$t_4$ (N by NW)	Hitchcock	Grant	Thriller	$c_2$	$d_1$
$t_5$ (Bishop's Wife)	Koster	Grant	Comedy	$c_2$	$d_2$
$t_6$ (Harvey)	Koster	Stewart	Comedy	$c_2$	$d_2$

Table 1: An instance of the movie database

Consider partitioning of the tuples in Table 1 into two clusters. Clustering **C** groups the first two movies together into one cluster,  $c_1$ , and the remaining four into another,  $c_2$ . Note that cluster  $c_1$  preserves all information about the actor and the genre of the movies it holds. For objects in  $c_1$ , we know with certainty that the genre is “Crime”, the actor is “De Niro” and there are only two possible values for the director. Cluster  $c_2$  involves only two different values for each attribute. Any other clustering will result in greater information loss. For example, in clustering **D**,  $d_2$  is equally as informative as  $c_1$ , but  $d_1$  includes three different actors and three different directors. So, while in  $c_2$  there are two equally likely values for each attribute, in  $d_1$  the director is any of “Scorsese”, “Coppola”, or “Hitchcock” (with respective probabilities 0.25, 0.25, and 0.50), and similarly for the actor.

This intuitive idea was formalized by Tishby, Pereira and Bialek [16]. They recast clustering as the compression of one random variable into a compact representation that preserves as much information as possible about another random variable. Their approach was named the *Information Bottleneck (IB)* method, and it has been applied to a variety of different areas. In this paper, we consider the application of the IB method to the problem of clustering large data sets of categorical data. x

We formulate the problem of clustering relations with categorical attributes within the Information Bottleneck framework, and define dissimilarity between categorical data objects based on the IB method. Our contributions are

the following.

- We propose LIMBO, the first scalable hierarchical algorithm for clustering categorical data based on the IB method. As a result of its hierarchical approach, LIMBO allows us in a single execution to consider clusterings of various sizes. Depending on the requirements of the user, LIMBO can control either the size, or the accuracy of the model it builds to summarize the data.
- We use LIMBO to cluster both tuples and attribute values. We define a novel distance between attribute values that allows us to quantify the degree of interchangeability of attribute values within a single attribute.
- We empirically evaluate the quality of clusterings produced by LIMBO relative to other categorical clustering algorithms including the tuple clustering algorithms IB, ROCK [10], and COOLCAT [2]; as well as the attribute value clustering algorithm STIRR [9]. We compare the clusterings based on a comprehensive set of quality metrics.
- We examine heuristics based on information theoretic measures to determine the numbers of clusters into which a given data set can be most naturally partitioned.

The rest of the paper is structured as follows. In Section 2, we present the IB method, and in Section 3, we describe how to apply IB to the problem of clustering categorical data. In Section 4, we introduce LIMBO, and Section 5 presents the experimental evaluation of LIMBO and other algorithms. Section 6 addresses the problem of identifying a natural number of clusters in a given data set. Section 7 describes related work on categorical clustering, and Section 8 concludes the paper.

## 2 Background

In this section, we review some of the concepts from information theory that will be used in the rest of the paper. We also provide an outline of the Information Bottleneck method, and its application to the problem of clustering.

### 2.1 Information Theory basics

The following definitions can be found in any information theory textbook, *e.g.*, [5]. Let  $T$  denote a discrete random variable that takes values over the set  $\mathbf{T}$ , and let  $p(t)$  denote the probability mass function of  $T$ . The *entropy*  $H(T)$

of variable  $T$  is defined by

$$H(T) = - \sum_{t \in \mathbf{T}} p(t) \log p(t) .$$

The entropy  $H(T)$  can be thought of as the minimum number of bits on average required to describe the random variable  $T$ . Intuitively, entropy captures the “uncertainty” of variable  $T$ ; the higher the entropy, the lower the certainty with which we can predict the value of the variable  $T$ .

Now, let  $T$  and  $A$  be two random variables that range over sets  $\mathbf{T}$  and  $\mathbf{A}$  respectively, and let  $p(t, a)$  denote their joint distribution and  $p(a|t)$  be the conditional distribution of  $A$  given  $T$ . Then *conditional entropy*  $H(A|T)$  is defined as

$$\begin{aligned} H(A|T) &= \sum_{t \in \mathbf{T}} p(t) H(A|T = t) \\ &= - \sum_{t \in \mathbf{T}} p(t) \sum_{a \in \mathbf{A}} p(a|t) \log p(a|t) . \end{aligned}$$

Given  $T$  and  $A$ , the *mutual information*,  $I(T; A)$ , quantifies the amount of information that the variables hold about each other. The mutual information between two variables is the amount of uncertainty (entropy) in one variable that is removed by knowledge of the value of the other one. Specifically, we have

$$\begin{aligned} I(T; A) &= \sum_{t \in \mathbf{T}} \sum_{a \in \mathbf{A}} p(t, a) \log \frac{p(t, a)}{p(t)p(a)} \\ &= \sum_{t \in \mathbf{T}} p(t) \sum_{a \in \mathbf{A}} p(a|t) \log \frac{p(a|t)}{p(a)} \\ &= H(t) - H(t|a) = H(a) - H(a|t) . \end{aligned}$$

Mutual information is symmetric, non-negative and equals zero if and only if  $T$  and  $A$  are independent.

*Relative Entropy*, or the *Kullback-Leibler (KL) divergence*, is a standard information-theoretic measure of the difference between two probability distributions. Given two distributions  $p$  and  $q$  over a set  $\mathbf{T}$ , the relative entropy is

$$D_{KL}[p||q] = \sum_{t \in \mathbf{T}} p(t) \log \frac{p(t)}{q(t)} .$$

Intuitively, the relative entropy  $D_{KL}[p||q]$  is a measure of the redundancy in an encoding that assumes the distribution  $q$ , when the true distribution is  $p$ .

## 2.2 The Information Bottleneck Method

Let  $\mathbf{T}$  denote a set of objects that we want to cluster (e.g., customers, tuples in a relation, web documents), and assume that the elements in  $\mathbf{T}$  are expressed as vectors in a feature space  $\mathbf{A}$  (e.g., items purchased, words, attribute values, links). That is, each element of  $\mathbf{T}$  is associated with a sequence of values from  $\mathbf{A}$ . In Section 3, we describe in detail the types of datasets that we consider. Let  $n = |\mathbf{T}|$  and  $d = |\mathbf{A}|$ . Our data can then be conceptualized as an  $n \times d$  matrix  $M$ , where each row holds the feature vector of an object in  $\mathbf{T}$ . Now let  $T, A$  be random variables that range over the sets  $\mathbf{T}$  and  $\mathbf{A}$  respectively. We normalize matrix  $M$  so that the entries of each row sum up to one. For some object  $t \in \mathbf{T}$ , the corresponding row of the normalized matrix holds the conditional probability  $p(A|T = t)$ . The information that one variable contains about the other can be quantified using the mutual information  $I(T; A)$  measure. Furthermore, if we fix a value  $t \in \mathbf{T}$ , the conditional entropy  $H(A|T = t)$  gives the uncertainty of a value for variable  $A$  selected among those associated with the object  $t$ .

A  $k$ -clustering  $\mathbf{C}_k$  of the elements of  $\mathbf{T}$  partitions them into  $k$  clusters  $\mathbf{C}_k = \{c_1, c_2, c_3, \dots, c_k\}$ , where each cluster  $c_i \in \mathbf{C}$  is a non-empty subset of  $\mathbf{T}$  such that  $c_i \cap c_j = \emptyset$  for all  $i, j, i \neq j$ , and  $\cup_{i=1}^k c_i = \mathbf{T}$ . Let  $C_k$  denote a random variable that ranges over the clusters in  $\mathbf{C}_k$ . We define  $k$  to be the *size* of the clustering. When  $k$  is fixed or when it is immaterial to the discussion, we will use  $\mathbf{C}$  and  $C$  to denote the clustering and the corresponding random variable.

Now, let  $\mathbf{C}$  be a specific clustering. Giving equal weight to each element  $t \in \mathbf{T}$ , we define  $p(t) = \frac{1}{n}$ . Then, for  $c \in \mathbf{C}$ , the elements of  $\mathbf{T}$ ,  $\mathbf{A}$ , and  $\mathbf{C}$  are related as follows:

$$\begin{aligned}
 p(c|t) &= \begin{cases} 1 & \text{if } t \in c \\ 0 & \text{otherwise} \end{cases} \\
 p(c) &= \sum_{t \in c} p(t) \\
 p(a|c) &= \frac{1}{p(c)} \sum_{t \in c} p(t)p(a|t) .
 \end{aligned}$$

We seek clusterings of the elements of  $\mathbf{T}$  such that, for  $t \in c_i$ , knowledge of the cluster identity,  $c_i$ , provides essentially the same prediction of, or information about, the values in  $\mathbf{A}$  as does the specific knowledge of  $t$ . Just as  $I(A; T)$  measures the information about the values in  $\mathbf{A}$  provided by the identity of a specific element of  $\mathbf{T}$ ,  $I(A; C)$  measures the information about the values in  $\mathbf{A}$  provided by the identity of a cluster in  $\mathbf{C}$ . The higher  $I(A; C)$ , the more informative the cluster identity is about the values in  $\mathbf{Y}$  contained in the cluster. In the formalization

of Tishby, Pereira and Bialek [16], the problem of clustering is recast as the problem of compressing variable  $T$  while preserving information about variable  $A$ . Formally, they define clustering as an optimization problem, where, for a given number  $k$  of clusters, we wish to identify the  $k$ -clustering that maximizes  $I(A; C_k)$ . Intuitively, in this procedure, the information contained in  $T$  about  $A$  is “squeezed” through a compact “bottleneck” clustering  $\mathbf{C}_k$ , which is forced to represent the “relevant” part in  $T$  with respect to  $A$ . Tishby et al. [16] prove that, for a fixed number  $k$  of clusters, the optimal clustering  $\mathbf{C}_k$  partitions the objects in  $\mathbf{T}$  so that the average relative entropy  $\sum_{c \in \mathbf{C}_k, t \in \mathbf{T}} p(t, c) D_{KL}[p(a|t) || p(a|c)]$  is minimized.

Finding the optimal clustering is an NP-complete problem [8]. Slonim and Tishby [14] propose a greedy agglomerative approach, the *Agglomerative Information Bottleneck (AIB)* algorithm, for finding an informative clustering. The algorithm starts with the clustering  $\mathbf{C}_n$ , in which each object  $t \in \mathbf{T}$  is assigned to its own cluster. Due to the one-to-one mapping between  $\mathbf{C}_n$  and  $\mathbf{T}$ ,  $I(A; C) = I(A; X)$ ; that is, the clusters in  $\mathbf{C}_n$  contain the same information for the values in the set  $\mathbf{A}$  as the tuples in  $\mathbf{T}$ . The algorithm then proceeds iteratively, for  $n - k$  steps, reducing the number of clusters in the current clustering by one in each iteration. At step  $n - \ell + 1$  of the *AIB* algorithm, two clusters  $c_i, c_j$  in  $\ell$ -clustering  $\mathbf{C}_\ell$  are merged into a single component  $c^*$  to produce a new  $(\ell - 1)$ -clustering  $\mathbf{C}_{\ell-1}$ . As the algorithm forms clusterings of smaller size, the information that the clustering contains about the values in  $\mathbf{Y}$  decreases; that is,  $I(A; C_{\ell-1}) \leq I(A; C_\ell)$ . The clusters  $c_i$  and  $c_j$  to be merged are chosen to minimize the information loss in moving from clustering  $\mathbf{C}_\ell$  to clustering  $\mathbf{C}_{\ell-1}$ . This information loss is given by  $\delta I(c_i, c_j) = I(A; C_\ell) - I(A; C_{\ell-1})$ . We can also view the information loss as the increase in the uncertainty. Recall that  $I(A; C) = H(A) - H(A|C)$ . Since the value  $H(A)$  is independent of the clustering  $\mathbf{C}$ , maximizing the mutual information  $I(A; C)$  is the same as minimizing the entropy of the clustering  $H(A|C)$ .

After merging clusters  $c_i$  and  $c_j$ , the new component  $c^* = c_i \cup c_j$  has

$$p(c^*|t) = \begin{cases} 1 & \text{if } t \in c_i \text{ or } t \in c_j \\ 0 & \text{otherwise} \end{cases} \quad (1)$$

$$p(c^*) = p(c_i) + p(c_j) \quad (2)$$

$$p(A|c^*) = \frac{p(c_i)}{p(c^*)} p(A|c_i) + \frac{p(c_j)}{p(c^*)} p(A|c_j) . \quad (3)$$

Tishby et al. [16] show that

$$\delta I(c_i, c_j) = [p(c_i) + p(c_j)] \cdot D_{JS}[p(A|c_i), p(A|c_j)] \quad (4)$$

where  $D_{JS}$  is the *Jensen-Shannon (JS)* divergence, defined as follows. Let  $p_i = p(a|c_i)$  and  $p_j = p(a|c_j)$  and let

$$\bar{p} = \frac{p(c_i)}{p(c^*)}p_i + \frac{p(c_j)}{p(c^*)}p_j$$

denote the weighted average distribution of distributions  $p_i$  and  $p_j$ . Then, the  $D_{JS}$  distance is:

$$D_{JS}[p_i, p_j] = \frac{p(c_i)}{p(c^*)}D_{KL}[p_i||\bar{p}] + \frac{p(c_j)}{p(c^*)}D_{KL}[p_j||\bar{p}].$$

The  $D_{JS}$  distance is the average  $D_{KL}$  distance of  $p_i$  and  $p_j$  from  $\bar{p}$ . It is non-negative and equals zero if and only if  $p_i \equiv p_j$ . It is also bounded above by one, and it is symmetric. We note that the information loss for merging clusters  $c_i$  and  $c_j$ , depends only on the clusters  $c_i$  and  $c_j$ , and not on other parts of the clusterings  $\mathbf{C}_\ell$  and  $\mathbf{C}_{\ell-1}$ .

### 3 Clustering Categorical Data using the *IB* method

In this section, we formulate the problem of clustering categorical data in the context of the Information Bottleneck method, and we consider some novel applications of the method. We consider two types of data: *relational* data and *market-basket* data.

#### 3.1 Relational Data

In this case, the input to our problem is a set  $\mathbf{T}$  of  $n$  tuples on  $m$  attributes  $A_1, A_2, \dots, A_m$ . The domain of attribute  $A_i$  is the set  $\mathbf{A}_i = \{A_i.v_1, A_i.v_2, \dots, A_i.v_{d_i}\}$  so that identical values from different attributes are treated as distinct values. A tuple  $t \in \mathbf{T}$  takes exactly one value from the set  $\mathbf{A}_i$  for the  $i^{th}$  attribute. Let  $\mathbf{A} = \mathbf{A}_1 \cup \dots \cup \mathbf{A}_m$  denote the set of all possible attribute values. Let  $d = d_1 + d_2 + \dots + d_m$  denote the size of  $\mathbf{A}$ . We represent our data as an  $n \times d$  binary matrix  $M$ , where each  $t \in \mathbf{T}$  is a  $d$ -dimensional row vector in  $M$ .  $M[t, a] = 1$ , if tuple  $t$  contains attribute value  $a$ , and zero otherwise. Since every tuple contains one value for each attribute, each tuple vector contains exactly  $m$  1's.

Now, let  $T$  and  $A$  be random variables that range over sets  $\mathbf{T}$  and  $\mathbf{A}$  respectively. Following the formalism of Section 2, we define  $p(t) = 1/n$ , and we normalize the matrix  $M$  so that the  $t^{th}$  row holds the conditional probability



distribution  $p(A|t)$ . Since each tuple contains exactly  $m$  attribute values, for some  $a \in \mathbf{A}$ ,  $p(a|t) = 1/m$  if  $a$  appears in tuple  $t$ , and zero otherwise. Table 2 shows the normalized matrix  $M$  for the movie database example.<sup>1</sup> Given the normalized matrix, we can proceed with the application of the IB method to cluster the tuples in  $\mathbf{T}$ . Note that matrix  $M$  can be stored as a sparse matrix, so we do not need to materialize all  $n \times d$  entries.

	d.S	d.C	d.H	d.K	a.DN	a.S	a.G	g.Cr	g. T	g.C	p(t)
$t_1$	1/3	0	0	0	1/3	0	0	1/3	0	0	1/6
$t_2$	0	1/3	0	0	1/3	0	0	1/3	0	0	1/6
$t_3$	0	0	1/3	0	0	1/3	0	0	1/3	0	1/6
$t_4$	0	0	1/3	0	0	0	1/3	0	1/3	0	1/6
$t_5$	0	0	0	1/3	0	0	1/3	0	0	1/3	1/6
$t_6$	0	0	0	1/3	0	1/3	0	0	0	1/3	1/6

Table 2: The normalized movie table

Our approach merges all attribute values into one variable, without taking into account the fact that the values come from different attributes. Alternatively, we could define a random variable for every attribute  $A_i$ . We will now show that, in applying the Information Bottleneck method to the case of relational data, considering all attributes together is equivalent to considering each attribute independently.

Let  $A_i$  be a random variable that ranges over the set  $\mathbf{A}_i$ . For some  $a \in \mathbf{A}_i$ , and some  $t \in \mathbf{T}$  we use  $p(a|t)$  to denote the conditional probability  $p(A = a|t)$ , and  $p_i(a|t)$  to denote the conditional probability  $p(A_i = a|t)$ . Also let  $p(a)$  denote  $p(A = a)$ , and  $p_i(a)$  denote  $p(A_i = a)$ . Since each tuple takes exactly one value in each attribute,  $p_i(a|t) = 1$ , if  $a$  appears in  $t$ , and zero otherwise. From the definitions in Section ?? we have that  $p(a|t) = \frac{1}{m}p_i(a|t)$ , for all  $1 \leq i \leq m$ ,  $a \in \mathbf{A}_i$ , and  $t \in \mathbf{T}$ . It follows that  $p(a) = \frac{1}{m}p_i(a)$ . Furthermore, let  $c$  denote a cluster, and let  $|c|$  denote the number of tuples in  $c$ . Since  $p(a|c) = \frac{1}{|c|} \sum_{t \in c} p(a|t)$ , and  $p_i(a|c) = \frac{1}{|c|} \sum_{t \in c} p_i(a|t)$  we have that  $p(a|c) = \frac{1}{m}p_i(a|c)$ . Now let  $\mathbf{C}_k$  be a  $k$ -clustering, for  $1 \leq k \leq n$ , and let  $C_k$  be the corresponding random variable. We have that

$$H(A) = \frac{1}{m} \sum_{i=1}^m H(A_i) + \log m$$

<sup>1</sup>We use abbreviations for the attribute values. For example d.H stands for director.Hitchcock.

$$\begin{aligned}
H(A|C_k) &= \frac{1}{m} \sum_{i=1}^m H(A_i|C_k) + \log m \\
I(A; C_k) &= \frac{1}{m} \sum_{i=1}^m I(A_i; C_k) .
\end{aligned}$$

Given that  $C_n \equiv T$ , the information loss for some clustering  $C$  can be expressed as

$$I(A; T) - I(A; C) = \frac{1}{m} \sum_{i=1}^m (I(A_i; T) - I(A_i; C)) .$$

Therefore, minimizing the information loss for variable  $A$  is the same as the minimizing the sum of the information losses for all individual variables  $A_i$ .

### 3.2 Market-Basket Data

Market-basket data describes a database of transactions for a store, where every tuple consists of the items purchased by a single customer. It is also used as a term that collectively describes a data set where the tuples are sets of values of a single attribute, and each tuple may contain a different number of values. This is what distinguishes market basket from relational data where tuples contain one value from each of a fixed number of distinct attributes. In the case of market-basket data, the input to our problem is a set  $\mathbf{T}$  of  $n$  tuples on a single attribute  $A$ , with domain  $\mathbf{A}$ . Tuple  $t_i$  contains  $d_i$  values. If  $d$  is the size of the domain  $\mathbf{A}$ , we can represent our data as an  $n \times d$  matrix  $M$ , where each  $t \in \mathbf{T}$  is a  $d$ -dimensional row vector in  $M$ .  $M[t, a] = 1$ , if tuple  $t$  contains attribute value  $a$ , and zero otherwise. The vector for tuple  $t_i$  contains exactly  $d_i$  1's.

Now, let  $T$  and  $A$  be random variables that range over sets  $\mathbf{T}$  and  $\mathbf{A}$  respectively. For tuple  $t_i \in \mathbf{T}$ ,  $1 \leq i \leq n$  we define

$$\begin{aligned}
p(t_i) &= 1/n \\
p(a|t_i) &= \begin{cases} 1/d_i & \text{if } a \text{ appears in } t \\ 0 & \text{otherwise} \end{cases} .
\end{aligned}$$

We can now define the mutual information  $I(T; A)$  and proceed with the Information Bottleneck method to cluster the tuples in  $\mathbf{T}$ .

### 3.3 Intra-Attribute Value Distance

In this section we propose a novel application that can be used within LIMBO to quantify the distance between attribute values of the same attribute. Categorical data is characterized by the fact that there is no inherent distance between attribute values. For example, in the movie database instance, given the values “Scorsese” and “Coppola”, it is not apparent how to assess their similarity. Comparing the set of tuples in which they appear is not useful since every movie has a single director. In order to compare attribute values, we need to place them within a *context*. Then, two attribute values are similar if the contexts in which they appear are similar. We define the context as the distribution these attribute values induce on the remaining attributes. For example, for the attribute “director”, two directors are considered similar if they induce a “similar” distribution over the attributes “actor” and “genre”.

Formally, let  $A'$  be the attribute of interest, and let  $\mathbf{A}'$  denote the set of values of attribute  $A'$ . Also let  $\tilde{\mathbf{A}} = \mathbf{A} \setminus \mathbf{A}'$  denote the set of attribute values for the remaining attributes. For the example of the movie database, if  $A'$  is the director attribute, with  $\mathbf{A}' = \{d.S, d.C, d.H, d.K\}$ , then  $\tilde{\mathbf{A}} = \{a.DN, a.S, a.G, g.Cr, g.T, g.C\}$ . Let  $A'$  and  $\tilde{A}$  be random variables that range over  $\mathbf{A}'$  and  $\tilde{\mathbf{A}}$  respectively, and let  $p(\tilde{A}|v)$  denote the distribution that value  $v \in \mathbf{A}'$  induces on the values in  $\tilde{\mathbf{A}}$ . For some  $a \in \tilde{\mathbf{A}}$ ,  $p(a|v)$  is the fraction of the tuples in  $\mathbf{T}$  that contain  $v$ , and also contain value  $a$ . Also, for some  $v \in \mathbf{A}'$ ,  $p(v)$  is the fraction of tuples in  $\mathbf{T}$  that contain the value  $v$ . Table 3 shows an example of a table when  $A'$  is the director attribute.

director	a.DN	a.S	a.G	g.Cr	g.T	g.C	p(d)
Scorsese	1/2	0	0	0	1/2	0	1/6
Coppola	1/2	0	0	0	1/2	0	1/6
Hitchcock	0	1/3	1/3	0	2/3	0	2/6
Koster	0	1/3	1/3	0	0	2/3	2/6

Table 3: The “director” attribute

For two values  $v_1, v_2 \in \mathbf{A}'$ , we define the distance between  $v_1$  and  $v_2$  to be the information loss  $\delta I(v_1, v_2)$ , incurred about the variable  $\tilde{A}$  if we merge values  $v_1$  and  $v_2$ . This is equal to the increase in the uncertainty of predicting the values of variable  $\tilde{A}$ , when we replace values  $v_1$  and  $v_2$  with  $v_1 \vee v_2$ . In the movie example, Scorsese

and Coppola are the most similar directors.<sup>2</sup>

The definition of a distance measure for categorical attribute values is a contribution in itself, since it imposes some structure on an inherently unstructured problem. We can define a distance measure between tuples as the sum of the distances of the individual attributes. Another possible application is to cluster intra-attribute values. For example, in a movie database, we may be interested in discovering clusters of directors or actors, which in turn could help in improving the classification of movie tuples. Given the joint distribution of random variables  $A'$  and  $\tilde{A}$  we can apply the LIMBO algorithm for clustering the values of attribute  $A'$ . Merging two  $v_1, v_2 \in A'$ , produces a new value  $v_1 \vee v_2$ , where  $p(v_1 \vee v_2) = p(v_1) + p(v_2)$ , since  $v_1$  and  $v_2$  never appear together. Also,

$$p(a|v_1 \vee v_2) = \frac{p(v_1)}{p(v_1 \vee v_2)}p(a|v_1) + \frac{p(v_2)}{p(v_1 \vee v_2)}p(a|v_2) .$$

The problem of defining a context sensitive distance measure between attribute values is also considered by Das and Mannila [6]. They define an iterative algorithm for computing the *interchangeability* of two values. We believe that our approach gives a natural quantification of the concept of interchangeability. Furthermore, our approach has the advantage that it allows for the definition of distance between clusters of values, which can be used to perform intra-attribute value clustering. Gibson et al. [9] proposed STIRR, an algorithm that clusters attribute values. STIRR does not define a distance measure between attribute values and, furthermore, produces just two clusters of values.

## 4 scaLable InforMation BOttleneck (*LIMBO*) Clustering

The Agglomerative Information Bottleneck algorithm suffers from high computational complexity, namely  $\mathcal{O}(n^2 d^2 \log n)$ , which is prohibitive for large data sets. We now introduce the *scaLable InforMation BOttleneck*, *LIMBO*, algorithm that uses distributional summaries in order to deal with large data sets. LIMBO is based on the idea that we do not need to keep whole tuples, or whole clusters in main memory, but instead, just sufficient statistics to describe them. LIMBO produces a compact summary model of the data, and then performs clustering on the summarized data. We present two versions of our algorithm: in the first, LIMBO<sub>S</sub>, we bound the the size of our summary model, and in the second, LIMBO<sub>ϕ</sub>, we control the accuracy of the model by bounding the loss in mutual information. We employ

---

<sup>2</sup>A conclusion that agrees with a well-informed cinematic opinion.

an approach similar to the one used in the BIRCH clustering algorithm for clustering numerical data [17]. However, we use an IB inspired notion of distance and a novel definition of summaries to produce the solution.

## 4.1 Distributional Cluster Features

We summarize a cluster of tuples in a *Distributional Cluster Feature (DCF)*. We will use the information in the relevant *DCFs* to compute the distance between two clusters or between a cluster and a tuple.

Let  $\mathbf{T}$  denote a set of tuples over a set  $\mathbf{A}$  of attributes, and let  $T$  and  $A$  be the corresponding random variables, as described earlier. Also let  $\mathbf{C}$  denote a clustering of the tuples in  $\mathbf{T}$  and let  $C$  be the corresponding random variable. For some cluster  $c \in \mathbf{C}$ , the *Distributional Cluster Feature (DCF)* of cluster  $c$  is defined by the pair

$$DCF(c) = \left( p(c), p(A|c) \right)$$

where  $p(c)$  is the probability of cluster  $c$ , and  $p(A|c)$  is the conditional probability distribution of the attribute values given the cluster  $c$ . We will often use  $DCF(c)$  and  $c$  interchangeably.

If  $c$  consists of a single tuple  $t \in \mathbf{T}$ ,  $p(t) = 1/n$ , and  $p(A|t)$  is computed as described in Section 2. For example, in the movie database, for tuple  $t_i$ ,  $DCF(t_i)$  corresponds to the  $i^{th}$  row of the normalized matrix  $M$  in Table 2. For larger clusters, the *DCF* is computed recursively as follows. Let  $c^*$  denote the cluster we obtain by merging two clusters  $c_1$  and  $c_2$ . The *DCF* of the cluster  $c^*$  is equal to

$$DCF(c^*) = \left( p(c^*), p(A|c^*) \right)$$

where  $p(c^*)$  and  $p(A|c^*)$  are computed using Equations 2, and 3 respectively.

We define the distance,  $d(c_1, c_2)$ , between  $DCF(c_1)$  and  $DCF(c_2)$  as the information loss  $\delta I(c_1, c_2)$  incurred for merging the corresponding clusters  $c_1$  and  $c_2$ . The distance  $d(c_1, c_2)$  is computed using Equation 4. The information loss depends only on the clusters  $c_1$  and  $c_2$ , and not on the clustering  $\mathbf{C}$  in which they belong. Therefore,  $d(c_1, c_2)$  is a well-defined distance measure independent of the *DCF* tree.

The *DCFs* can be stored and updated incrementally. The probability vectors are stored as sparse vectors, reducing the amount of space considerably. Each *DCF* provides a summary of the corresponding cluster which is sufficient for computing the distance between two clusters.

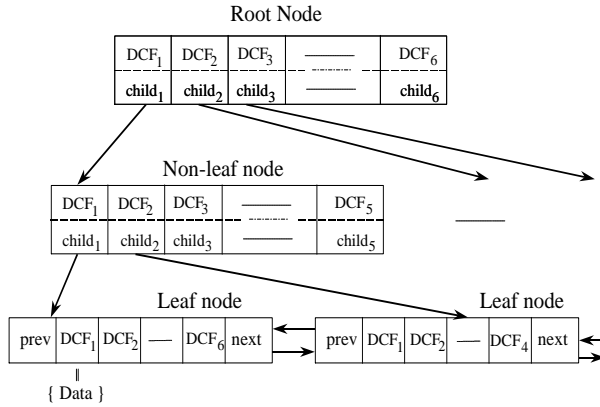

Figure 1: A *DCF* tree with branching factor 6.

## 4.2 The *DCF* tree

The *DCF* tree is a height-balanced tree as depicted in Figure 1. Each node in the tree contains  $B$  entries, where  $B$  is the *branching factor* of the tree. All node entries store *DCF*s. At any point in the construction of the tree, the *DCF*s at the leaves define a clustering of the tuples seen so far. Each non-leaf node stores *DCF*s that are produced by merging the *DCF*s of its children. The *DCF* tree is built in a B-tree-like dynamic fashion. The insertion algorithm is described in detail below. After all tuples are inserted in the tree, the *DCF* tree embodies a compact representation in which the data set is summarized by the information in the *DCF*s of the leaves.

## 4.3 The LIMBO clustering algorithm

The LIMBO algorithm proceeds in three phases. In the first phase, the *DCF* tree is constructed to summarize the data. In the second phase, the *DCF*s of the tree leaves are merged to produce a chosen number of clusters. In the third phase, we associate each tuple with the *DCF* to which the tuple is closest.

**Phase 1: Insertion into the *DCF* tree.** Tuples are read and inserted one by one. Tuple  $t$  is converted into  $DCF(t)$ , as described in Section 4.1. Then, starting from the root, we trace a path downward in the *DCF* tree. When at a non-leaf node, we compute the distance between  $DCF(t)$  and each *DCF* entry of the node, finding the closest *DCF* entry to  $DCF(t)$ . We follow the child pointer of this entry to the next level of the tree. When at a leaf node, let  $DCF(c)$  denote the *DCF* entry in the leaf node that is closest to  $DCF(t)$ .  $DCF(c)$  is the summary of some cluster  $c$ . At this point we need to decide whether  $t$  will be absorbed in the cluster  $c$  or not.

We use two criteria depending on whether we are controlling the size of the model ( $\text{LIMBO}_S$ ), or the accuracy of the model ( $\text{LIMBO}_\phi$ ).

**LIMBO<sub>S</sub>:** In our space-bounded algorithm, an input parameter  $S$  indicates the maximum space bound. Let  $E$  be the maximum size of a  $DCF$  entry (note that sparse  $DCF$ s may be smaller than  $E$ ). We compute the maximum number of nodes ( $N = S/(EB)$ ) and keep a counter of the number of used nodes as we build the tree. If there is an empty entry in the leaf node that contains  $DCF(c)$ , then  $DCF(t)$  is placed in that entry. If there is no empty leaf entry and there is sufficient free space, then the leaf node is split into two leaves. This is done in a manner similar to that in BIRCH [17]. We find the two  $DCF$ s in the leaf node that are farthest apart and we use them as seeds for the new leaves. The remaining  $DCF$ s, and  $DCF(t)$  are placed in the leaf that contains the seed  $DCF$  to which they are closest. Finally, if the space bound has been reached, then we compare  $d(c, t)$  with the minimum distance of any two  $DCF$  entries in the leaf. If  $d(c, t)$  is smaller than this minimum, we merge  $DCF(t)$  with  $DCF(c)$ ; otherwise the two closest entries are merged and  $DCF(t)$  occupies the freed entry.

**LIMBO<sub>ϕ</sub>:** Alternatively, if wish to control the accuracy of the model, rather than its size, we use a threshold on the distance  $d(c, t)$  to determine whether to merge  $DCF(t)$  with  $DCF(c)$ , thus controlling directly the information loss for merging tuple  $t$  with cluster  $c$ . The selection of an appropriate threshold value will necessarily be data dependent and we require an intuitive way of allowing a user to set this threshold. Within a data set, every tuple contributes, on “average”,  $I(A; T)/n$  to the mutual information  $I(A; T)$ . We define the clustering threshold to be a multiple  $\phi$  of this average and we denote the threshold by  $\tau(\phi)$ . That is,

$$\tau(\phi) = \phi \frac{I(A; T)}{n}$$

We can make a pass over the data, or use a sample of the data, to estimate  $I(A; T)$ . Given a value for  $\phi$  ( $0 \leq \phi \ll n$ ), if a merge incurs information loss more than  $\phi$  times the “average” mutual information, then the new tuple is placed in a cluster by itself. In the extreme case  $\phi = 0.0$ , we prohibit any information loss in our summary. We discuss the effect of  $\phi$  in Section 5.4.

For both algorithms, when a leaf node is split, resulting in the creation of a new leaf node, the leaf’s parent is updated, and a new entry is created at the parent node that describes the newly created leaf. If there is space in the non-leaf node, we add a new  $DCF$  entry, otherwise the non-leaf node must also be split. This process continues upward in the tree until the root is either updated or split itself. In the latter case, the height of the tree increases

by one.

**Phase 2: Clustering.** After the construction of the *DCF* tree, the leaf nodes hold the *DCF*s of a clustering  $\tilde{\mathbf{C}}$  of the tuples in  $\mathbf{T}$ . Each  $DCF(c)$  corresponds to a cluster  $c \in \tilde{\mathbf{C}}$ , and contains sufficient statistics for computing  $p(A|c)$ , and probability  $p(c)$ . We employ the *Agglomerative Information Bottleneck (AIB)* algorithm to cluster the *DCF*s in the leaves and produce clusterings of the *DCF*s. We note that any clustering algorithm is applicable at this phase of the algorithm.

**Phase 3: Associating tuples with clusters.** For a chosen value of  $k$ , Phase 2 produces  $k$  *DCF*s that serve as *representatives* of  $k$  clusters. In the final phase, we perform a scan over the data set and assign each tuple to the cluster whose representative is closest to the the tuple.

#### 4.4 Analysis of LIMBO

We now present an analysis of the I/O and CPU costs for each phase of the LIMBO algorithm. In what follows,  $n$  is the number of tuples in the data set,  $d$  is the total number of attribute values,  $B$  is the branching factor of the *DCF* tree, and  $k$  is the chosen number of clusters.

**Phase 1:** The I/O cost of this stage is a scan that involves reading the data set from the disk. For the CPU cost, when a new tuple is inserted the algorithm considers a path of nodes in the tree, and for each node in the path, it performs at most  $B$  operations (distance computations, or updates), each taking time  $\mathcal{O}(d)$ . Thus, if  $h$  is the height of the *DCF* tree produced in Phase 1, locating the correct leaf node for a tuple takes time  $\mathcal{O}(hdB)$ . The time for a split is  $\mathcal{O}(dB^2)$ . If  $U$  is the number of non-leaf nodes, then all splits are performed in time  $\mathcal{O}(dUB^2)$  in total. Hence, the CPU cost of creating the *DCF* tree is  $\mathcal{O}(nhdB + dUB^2)$ . As in BIRCH, we observed experimentally that LIMBO produces compact trees of small height. For LIMBO<sub>S</sub>, both  $h$  and  $U$  are bounded.

**Phase 2:** For values of  $\phi$  and  $S$  that produce clusterings of high quality the *DCF* tree is compact enough to fit in main memory. Hence, there is no I/O cost involved in this phase, since it involves only the clustering of the leaf node entries of the *DCF* tree. If  $L$  is the number of *DCF* entries at the leaves of the tree, then the AIB algorithm takes time  $\mathcal{O}(L^2 d^2 \log L)$ . In our experiments,  $L \ll n$ , so the CPU cost is low.

**Phase 3:** The I/O cost of this phase is the reading of the data set from the disk again. The CPU complexity is  $\mathcal{O}(kdn)$ , since each tuple is compared against the  $k$  *DCF*s that represent the clusters.



## 5 Experimental Evaluation

In this section, we perform a comparative experimental evaluation of the LIMBO algorithms on both real and synthetic data sets. We compare both versions of LIMBO with other categorical clustering algorithms, including what we believe to be the only other scalable information-theoretic clustering algorithm COOLCAT [1, 2].

### 5.1 Algorithms

We compare the clustering quality of LIMBO with the following algorithms.

**ROCK Algorithm.** ROCK [10] assumes a similarity measure between tuples, and defines a *link* between two tuples whose similarity exceeds a threshold  $\theta$ . The aggregate interconnectivity between two clusters is defined as the sum of links between their tuples. ROCK proceeds hierarchically, merging the two most interconnected clusters in each step. Thus, ROCK is not applicable to large data sets. We use the *Jaccard Coefficient* for the similarity measure as suggested in the original paper. For data sets that appear in the original ROCK paper, we set the threshold  $\theta$  to the value suggested there, otherwise we set  $\theta$  to the value that gave us the best results in terms of quality. For our experimentation, we use the implementation of Guha et al. [10].

**COOLCAT Algorithm.** The approach most similar to ours is the COOLCAT algorithm [1, 2], by Barbará, Couto and Li. The COOLCAT algorithm is a scalable algorithm that optimizes the same objective function as our approach, namely the entropy of the clustering. It differs from our approach in that it relies on sampling, and it is non-hierarchical. COOLCAT starts with a sample of points and identifies a set of  $k$  initial tuples such that the minimum pairwise distance among them is maximized. These serve as representatives of the  $k$  clusters. All remaining tuples of the data set are placed in one of the clusters such that, at each step, the increase in the entropy of the resulting clustering is minimized. For the experiments, we implement COOLCAT based on the CIKM paper by Barbarà et al. [2].

**STIRR Algorithm.** STIRR [9] applies a *linear dynamical system* over multiple copies of a hypergraph of weighted attribute values, until a *fixed point* is reached. Each copy of the hypergraph contains two groups of attribute values, one with positive and another with negative weights, which define the two clusters. We compare this algorithm with our intra-attribute value clustering algorithm. In our experiments, we use our own implementation and report results for ten iterations.

## 5.2 Data Sets

We experimented with the following data sets. The first three have been previously used for the evaluation of the aforementioned algorithms [2, 9, 10]. The synthetic data sets are used both for quality comparison, and for our scalability evaluation.

**Congressional Votes:** This relational data set was taken from the *UCI Machine Learning Repository*.<sup>3</sup> It contains 435 tuples of votes from the U.S. Congressional Voting Record of 1984. Each tuple is a congress-person's vote on 16 issues and each vote is boolean, either YES or NO. Each congress-person is classified as either Republican or Democrat. There are a total of 168 Republicans and 267 Democrats. There are 288 missing values that we treat as separate values.

**Mushroom:** The Mushroom relational data set also comes from the UCI Repository. It contains 8,124 tuples, each representing a mushroom characterized by 22 attributes, such as color, shape, odor, etc. The total number of distinct attribute values is 117. Each mushroom is classified as either poisonous or edible. There are 4,208 edible and 3,916 poisonous mushrooms in total. There are 2,480 missing values.

**Database and Theory Bibliography.** This relational data set contains 8,000 tuples that represent research papers. About 3,000 of the tuples represent papers from database research and 5,000 tuples represent papers from theoretical computer science. Each tuple contains four attributes with values for the first Author, second Author, Conference/Journal and the Year of publication.<sup>4</sup> We use this data to test our intra-attribute clustering algorithm.

**Synthetic Data Sets.** We produce synthetic data sets using a data generator available on the Web.<sup>5</sup> This generator offers a wide variety of options, in terms of the number of tuples, attributes, and attribute domain sizes. We specify the number of classes in the data set by the use of conjunctive rules of the form  $(Attr_1 = a_1 \wedge Attr_2 = a_2 \wedge \dots) \Rightarrow Class = c1$ . The rules may involve an arbitrary number of attributes and attribute values. We name these synthetic data sets by the prefix DS followed by the number of classes in the data set, e.g., DS5 or DS10. The data sets contain 5,000 tuples, and 10 attributes, with domain sizes between 20 and 40 for each attribute. Three attributes participate

---

<sup>3</sup><http://www.ics.uci.edu/~mllearn/MLRepository.html>

<sup>4</sup>Following the approach of Gibson et al. [9] if the second author does not exist, then the name of the first author is copied instead.

We also filter the data so that each conference/journal appears at least 5 times.

<sup>5</sup><http://www.datgen.com/>

in the rules the data generator uses to produce the class labels. Additional larger synthetic data sets are described in Section 5.6.

**Web Data:** This is a market-basket data set that consists of a collection of web pages. The pages were collected as described by Kleinberg [11]. A query is made to a search engine, and an initial set of web pages is retrieved. This set is augmented by including pages that point to, or are pointed to by pages in the set. Then, the links between the pages are discovered, and the underlying graph is constructed. Following the terminology of Kleinberg [11] we define a *hub* to be a page with non zero out-degree, and an *authority* to be a page with non zero in-degree.

Our goal is to cluster the authorities in the graph. The set of tuples  $\mathbf{T}$  is the set of authorities in the graph, while the set of attribute values  $\mathbf{A}$  is the set of hubs. Each authority is expressed as a vector over the hubs that point to this authority. For our experiments, we use the data set used by Borodin et al. [3] for the “abortion” query. We applied a filtering step to assure that each hub points to more than 10 authorities and each authority is pointed by more than 10 hubs. The data set contains 93 authorities related to 102 hubs.

All data sets are summarized in Table 4.

Data Set	Records	Attributes	Attr. Values	Missing
Votes	435	16	48	288
Mushroom	8,124	22	117	2,480
Bibliographic	8,000	4	9,587	0
Web Data	93	102	102	0
DS5	5,000	10	314	0
DS10	5,000	10	305	0

Table 4: Summary of the data sets used

### 5.3 Quality Measures for Clustering

Clustering quality lies in the eye of the beholder; determining the best clustering usually depends on subjective criteria. Consequently, we will use several quantitative measures of clustering performance.

**Information Loss, (IL):** We use the information loss,  $I(A;T) - I(A;C)$  to compare clusterings. The lower the information loss, the better the clustering. For a clustering with low information loss, given a cluster, we can predict the attribute values of the tuples in the cluster with relatively high accuracy.

**Category Utility, (CU):** Category utility [12], is defined as the difference between the expected number of attribute values that can be correctly guessed given a clustering, and the expected number of correct guesses with no such knowledge. Let  $\mathbf{C}$  be a clustering. If  $A_i$  is an attribute with values  $v_{ij}$ , then  $CU$  is given by the following expression:

$$CU = \sum_{c \in \mathbf{C}} \frac{|c|}{n} \sum_i \sum_j [P(A_i = v_{ij}|c)^2 - P(A_i = v_{ij})^2]$$

Many data sets commonly used in testing clustering algorithms include a variable that is hidden from the algorithm, and specifies the class with which each tuple is associated. All data sets we consider include such a variable. This variable is *not* used by the clustering algorithms. While there is no guarantee that any given classification corresponds to an optimal clustering, it is nonetheless enlightening to compare clusterings with pre-specified classifications of tuples. To do this, we use the following quality measures.

**Min Classification Error, ( $E_{min}$ ):** Assume that the tuples in  $\mathbf{T}$  are already classified into  $k$  classes  $\mathbf{G} = \{g_1, \dots, g_k\}$ , and let  $\mathbf{C}$  denote a clustering of the tuples in  $\mathbf{T}$  into  $k$  clusters  $\{c_1, \dots, c_k\}$  produced by a clustering algorithm. Consider a one-to-one mapping,  $f$ , from classes to clusters, such that each class  $g_i$  is mapped to the cluster  $f(g_i)$ . The *classification error* of the mapping is defined as

$$E = \sum_{i=1}^k |g_i \cap \overline{f(g_i)}|$$

where  $|g_i \cap \overline{f(g_i)}|$  measures the number of tuples in class  $g_i$  that received the wrong label. The *optimal* mapping between clusters and classes, is the one that minimizes the classification error. We use  $E_{min}$  to denote the classification error of the optimal mapping.

**Precision, (P), Recall, (R):** Without loss of generality assume that the optimal mapping assigns class  $g_i$  to cluster  $c_i$ . We define precision,  $P_i$ , and recall,  $R_i$ , for a cluster  $c_i$ ,  $1 \leq i \leq k$  as follows.

$$P_i = \frac{|c_i \cap g_i|}{|c_i|} \quad \text{and} \quad R_i = \frac{|c_i \cap g_i|}{|g_i|}.$$

$P_i$  and  $R_i$  take values between 0 and 1 and, intuitively,  $P_i$  measures the accuracy with which cluster  $c_i$  reproduces class  $g_i$ , while  $R_i$  measures the completeness with which  $c_i$  reproduces class  $g_i$ . We define the precision and recall of

the clustering as the weighted average of the precision and recall of each cluster. More precisely

$$P = \sum_{i=1}^k \frac{|g_i|}{|T|} P_i \quad \text{and} \quad R = \sum_{i=1}^k \frac{|g_i|}{|T|} R_i .$$

We think of precision, recall, and classification error as indicative values of the ability of the algorithm to reconstruct the existing classes in the data set.

In our experiments, we report values for all of the above measures. For LIMBO and COOLCAT, numbers are averages over 100 runs with different (random) orderings of the tuples.

## 5.4 Quality-Efficiency trade-offs for LIMBO

In LIMBO, we can control the accuracy of the model (using  $\phi$ ) or the size of the model (using  $S$ ). Both  $\phi$  and  $S$  permit a trade-off between the compactness of the model (number of leaf entries in the tree), and the expressiveness (information preservation) of the summarization it produces. For small values of  $\phi$  and large values of  $S$ , we obtain a fine grain representation of the data set at the end of Phase 1. However, this results in a tree with a large number of leaf entries, which leads to a higher computational cost for both Phase 1 and Phase 2 of the algorithm. For large values of  $\phi$  and small values of  $S$ , we obtain a compact representation of the data set (small number of leaf entries), which results in faster execution time, at the expense of increased information loss.

We now investigate this trade-off for a range of values for  $\phi$  and  $S$ . We observed experimentally that the branching factor  $B$  does not significantly affect the quality of the clustering. We set  $B = 4$ , which results in manageable execution time for Phase 1. Figure 2 presents the execution times for  $\text{LIMBO}_S$  and  $\text{LIMBO}_\phi$  on the DS5 data set, as a function of  $\phi$  and  $S$ . For  $\phi = 0.25$  the Phase 2 time is 210 seconds (beyond the edge of the graph). The figures also include the size of the tree in KBytes. In this figure, we observe that for small  $\phi$  and large  $S$  the computational bottleneck of the algorithm is Phase 2. As  $\phi$  increases and  $S$  decreases the time for Phase 2 decreases in a quadratic fashion. This agrees with the plot in Figure 3, where we observe that the number of leaves decreases also in a quadratic fashion. Due to the decrease in the size (and height) of the tree, time for Phase 1 also decreases, however, at a much slower rate. Phase 3, as expected, remains unaffected, and it is equal to a few seconds for all values of  $\phi$  and  $S$ . For  $\phi \geq 1.0$ , and  $S \leq 256\text{KB}$  the number of leaf entries becomes sufficiently small, so that the computational bottleneck of the algorithm becomes Phase 1. For these values the execution time is dominated by

	Votes	Mushroom	DS5	DS10
LIMBO $_{\phi}$	94.01%	99.77%	98.68%	98.82%
LIMBO $_S$	85.94%	99.34%	95.36%	95.28%

Table 5: Reduction in Leaf Entries

the linear scan of the data in Phase 1.

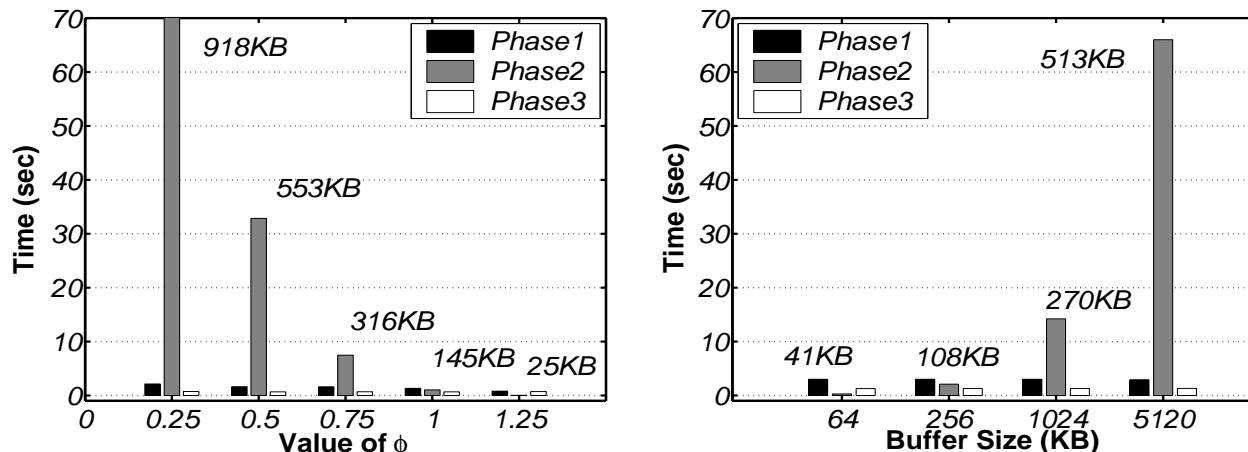

Figure 2: LIMBO $_{\phi}$  and LIMBO $_S$  execution times (DS5)

We now study the change in the quality measures for the same range of values for  $\phi$  and  $S$ . In the extreme cases of  $\phi = 0.0$  and  $S = \infty$ , we only merge identical tuples, and no information is lost in Phase 1. LIMBO then reduces to the AIB algorithm, and we obtain the same quality as AIB. Figures 4 and 5 show the quality measures for the different values of  $\phi$  and  $S$ . The  $CU$  value (not plotted) is equal to 2.51 for  $S \leq 256\text{KB}$ , and 2.56 for  $S \geq 256\text{KB}$ . We observe that for  $\phi \leq 1.0$  and  $S \geq 256\text{KB}$  we obtain clusterings of *exactly* the same quality as for  $\phi = 0.0$  and  $S = \infty$ , that is, the AIB algorithm. At the same time, for  $\phi = 1.0$  and  $S = 256\text{KB}$  the execution time of the algorithm is only a small fraction of that of the AIB algorithm, which was a few minutes.

Similar trends were observed for all other data sets. There is a range of values for  $\phi$ , and  $S$ , where the execution time of LIMBO is dominated by Phase 1, while at the same time, we observe essentially no change (up to the third decimal digit) in the quality of the clustering. Table 5 shows the reduction in the number of leaf entries for each data set for LIMBO $_{\phi}$  and LIMBO $_S$ . The parameters  $\phi$  and  $S$  are set so that the cluster quality is almost identical to that of AIB (as demonstrated in the tables in Section 5.5). These experiments demonstrate that in Phase 1 we

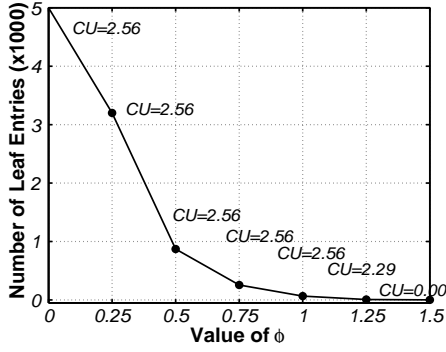

Figure 3: LIMBO $_{\phi}$  L. Entries (DS5)

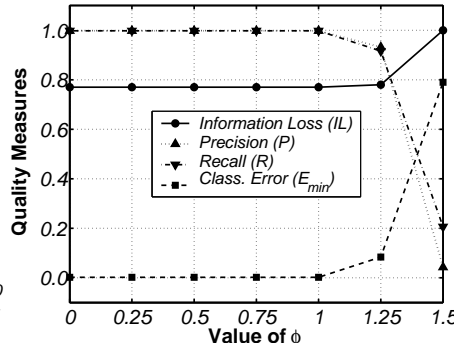

Figure 4: LIMBO $_{\phi}$  Quality (DS5)

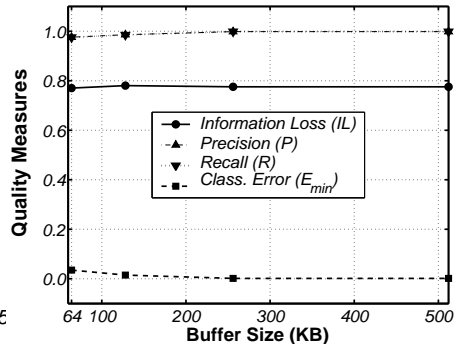

Figure 5: LIMBO $_S$  Quality (DS5)

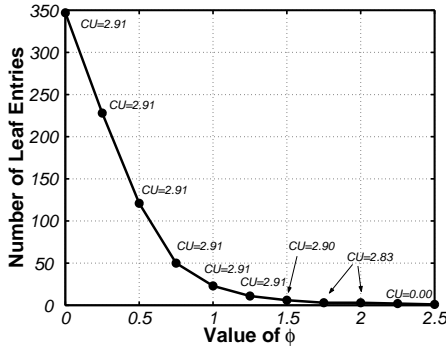

Figure 6: LIMBO $_{\phi}$  L. Entries (Votes)

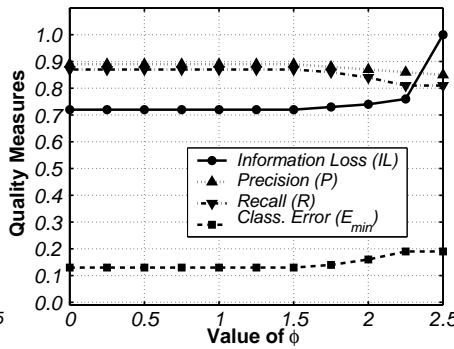

Figure 7: LIMBO $_{\phi}$  Quality (Votes)

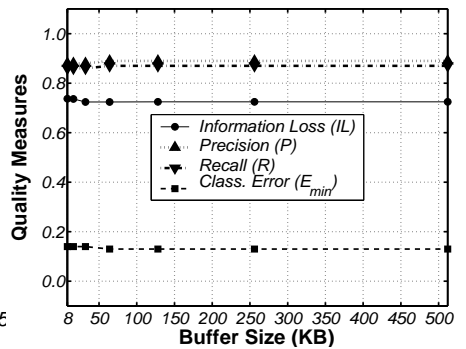

Figure 8: LIMBO $_S$  Quality (Votes)

can obtain significant compression of the data sets at no expense in the final quality. The consistency of LIMBO can be attributed in part to the effect of Phase 3, which assigns the tuples to cluster representatives, and hides some of the information loss incurred in the previous phases. Thus, it is sufficient for Phase 2 to discover  $k$  well separated representatives. As a result, even for large values of  $\phi$  and small values of  $S$ , LIMBO obtains essentially the same clustering quality as AIB, but in linear time. Similar figures are presented for all other data sets; Figures 6, 7 and 8 for Votes, Figures 9, 10 and 11 for Mushroom and Figures 12, 13 and 14 for DS10.

## 5.5 Comparative Evaluations

### 5.5.1 Comparison to Optimal Clustering

To get a better feel of how LIMBO performs on categorical data, we implemented a brute force algorithm (BF), that tries all possible clusterings and selects the one with the lowest information loss. Note that BF is computationally

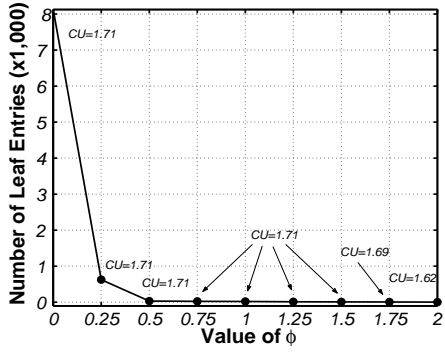

Figure 9: LIMBO $_{\phi}$  L. Ent. (Mush.m)

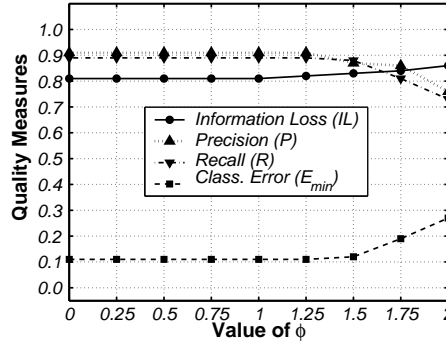

Figure 10: LIMBO $_{\phi}$  Qual. (Mush.)

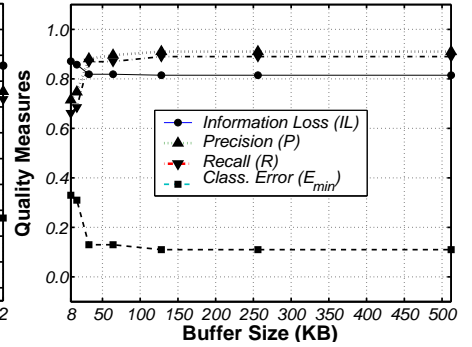

Figure 11: LIMBO $_S$  Qual. (Mush.)

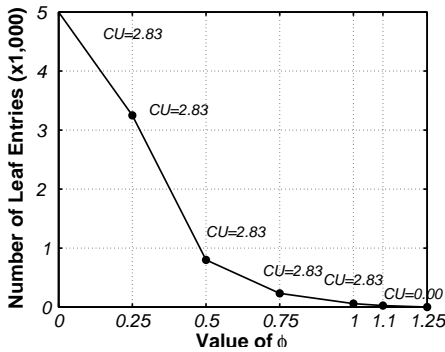

Figure 12: LIMBO $_{\phi}$  L. Entries (DS10)

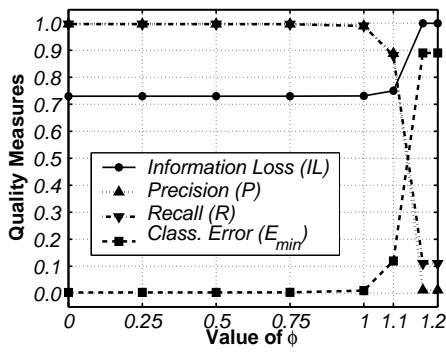

Figure 13: LIMBO $_{\phi}$  Quality (DS10)

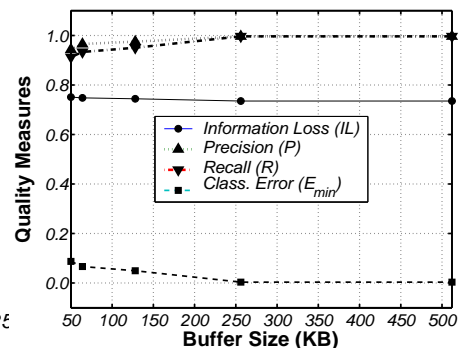

Figure 14: LIMBO $_S$  Quality (DS10)



feasible only if the number of tuples is quite small. We experimented with data sets of sizes  $n = 7$  and  $n = 8$  and for all clustering sizes  $k$ ,  $2 \leq k < n$ <sup>6</sup>. The data sets were produced using the synthetic data generator and they each contain 5 attributes, each one of them with a domain of size 3. We compared the information loss of the Brute Force algorithm against that of LIMBO $_{\phi}$  for  $\phi = 0.0$  (i.e. starting with each tuple in its own cluster). Results are given in Table 6.

$n, k$	Clusterings	BF	LIMBO
7,2	63	70%	71%
7,3	301	44%	44%
7,4	350	20%	20%
7,5	140	16%	16%
7,6	21	7%	7%
8,2	127	65%	65%
8,3	966	42%	42%
8,4	1701	35%	37%
8,5	1050	21%	21%
8,6	266	14%	14%
8,7	28	6%	6%

Table 6: Information Loss of Brute Force and LIMBO ( $\phi = 0.0$ )

With the sole exceptions of (7, 2) and (8, 4), for all other combinations of  $n, k$  in Table 6, LIMBO produces a clustering with information loss equal to the minimum information loss of any  $k$ -clustering of the  $n$  tuples. These results are indicative of the ability of the LIMBO algorithm to find an optimal, or nearly optimal clustering for a fixed  $k$ .

### 5.5.2 Tuple Clustering

---

<sup>6</sup>The total number of clusterings for given values of  $n$  and  $k$  is equal to the Stirling numbers of second order. Even for  $n = 20$  and  $k = 5$ , this number is equal to approximately  $7.5 \cdot 10^{11}$ .

Table 7 shows the results for all algorithms on all quality measures for the Votes and Mushroom data sets. For  $\text{LIMBO}_\phi$ , we present results for  $\phi = 1.0$  while for  $\text{LIMBO}_S$ , we present results for  $S = 128K$ . We can see that both version of LIMBO have results almost identical to the quality measures for  $\phi = 0.0$  and  $S = \infty$ , *i.e.*, the AIB algorithm. The *size* entry in the table holds the number of leaves for LIMBO, and the sample size for COOLCAT. For the Votes data set we use the whole data set as a sample, while for Mushroom we use 1,000 tuples. As Table 7 indicates, LIMBO’s quality is superior to ROCK, and COOLCAT, in both data sets. In terms of *IL*,

<i>Votes (2 clusters)</i>						
<b>Algorithm</b>	<i>size</i>	<i>IL(%)</i>	<i>P</i>	<i>R</i>	<i>E<sub>min</sub></i>	<i>CU</i>
LIMBO ( $\phi = 0.0, S = \infty$ )[AIB]	384	<b>72.52</b>	<b>0.89</b>	<b>0.87</b>	<b>0.13</b>	<b>2.89</b>
LIMBO ( $\phi = 1.0$ )	23	<b>72.55</b>	<b>0.89</b>	<b>0.87</b>	<b>0.13</b>	<b>2.89</b>
LIMBO ( $S = 128KB$ )	54	<b>72.54</b>	<b>0.89</b>	<b>0.87</b>	<b>0.13</b>	<b>2.89</b>
COOLCAT ( $s = 435$ )	435	73.55	0.87	0.85	0.15	2.78
ROCK ( $\theta = 0.7$ )	-	74.00	0.87	0.86	0.16	2.63
<i>Mushroom (2 clusters)</i>						
<b>Algorithm</b>	<i>size</i>	<i>IL(%)</i>	<i>P</i>	<i>R</i>	<i>E<sub>min</sub></i>	<i>CU</i>
LIMBO ( $\phi = 0.0, S = \infty$ )[AIB]	8124	<b>81.45</b>	<b>0.91</b>	<b>0.89</b>	<b>0.11</b>	<b>1.71</b>
LIMBO ( $\phi = 1.0$ )	18	<b>81.45</b>	<b>0.91</b>	<b>0.89</b>	<b>0.11</b>	<b>1.71</b>
LIMBO ( $S = 128KB$ )	54	<b>81.46</b>	<b>0.91</b>	<b>0.89</b>	<b>0.11</b>	<b>1.71</b>
COOLCAT ( $s = 1,000$ )	1,000	84.57	0.76	0.73	0.27	1.46
ROCK ( $\theta = 0.8$ )	-	86.00	0.77	0.57	0.43	0.59

Table 7: Results for real data sets

LIMBO created clusters which retained most of the initial information about the attribute values. With respect to the other measures, LIMBO outperforms all other algorithms, exhibiting the highest *CU*, *P* and *R* in all data sets tested, as well as the lowest *E<sub>min</sub>*.

We also evaluate LIMBO’s performance on two synthetic data sets, namely DS5 and DS10. These data sets allow us to evaluate our algorithm on data sets with more than two classes. The results are shown in Table 8.

<i>DS5 (n=5000, 10 attributes, 5 clusters)</i>						
<b>Algorithm</b>	<i>size</i>	<i>IL(%)</i>	<i>P</i>	<i>R</i>	<i>E<sub>min</sub></i>	<i>CU</i>
LIMBO ( $\phi = 0.0, S = \infty$ )[ <b>AIB</b> ]	5000	<b>77.56</b>	<b>0.998</b>	<b>0.998</b>	<b>0.002</b>	<b>2.56</b>
LIMBO ( $\phi = 1.0$ )	66	<b>77.56</b>	<b>0.998</b>	<b>0.998</b>	<b>0.002</b>	<b>2.56</b>
LIMBO ( $S = 1024KB$ )	232	<b>77.57</b>	<b>0.998</b>	<b>0.998</b>	<b>0.002</b>	<b>2.56</b>
COOLCAT ( $s = 125$ )	125	78.02	0.995	0.995	0.05	2.54
ROCK ( $\theta = 0.0$ )	-	85.00	0.839	0.724	0.28	0.44

<i>DS10 (n=5000, 10 attributes, 10 clusters)</i>						
<b>Algorithm</b>	<i>size</i>	<i>IL(%)</i>	<i>P</i>	<i>R</i>	<i>E<sub>min</sub></i>	<i>CU</i>
LIMBO ( $\phi = 0.0, S = \infty$ )[ <b>AIB</b> ]	5000	<b>73.50</b>	<b>0.997</b>	<b>0.997</b>	<b>0.003</b>	<b>2.82</b>
LIMBO ( $\phi = 1.0$ )	59	<b>73.51</b>	<b>0.994</b>	<b>0.996</b>	<b>0.004</b>	<b>2.82</b>
LIMBO ( $S = 1024KB$ )	236	<b>73.52</b>	<b>0.996</b>	<b>0.996</b>	<b>0.004</b>	<b>2.82</b>
COOLCAT ( $s = 125$ )	125	74.32	0.979	0.973	0.026	2.74
ROCK ( $\theta = 0.0$ )	-	78.00	0.830	0.818	0.182	2.13

Table 8: Results for synthetic data sets

We observe again that LIMBO has the lowest information loss and produces nearly optimal results with respect to precision and recall.

For the ROCK algorithm, we observed that it is very sensitive to the threshold value  $\theta$  and in many cases, the algorithm produces one giant cluster that includes tuples from most classes. This results in poor precision and recall.

**Comparison with COOLCAT.** COOLCAT exhibits average clustering quality that is close to that of LIMBO. It is interesting to examine how COOLCAT behaves when we consider other statistics. In Table 9, we present statistics for 100 runs of COOLCAT and LIMBO on different orderings of the Votes and Mushroom data sets. We present LIMBO’s results for  $\phi = 1.0$ , which are very similar to those for  $\phi = 0.0$ . For the Votes data set, COOLCAT exhibits information loss as high as 95.31% with a variance of 12.25%. For all runs, we use the whole data set as the sample for COOLCAT. For the Mushroom data set, the situation is better, but still the variance is as high as 3.5%. The

<b>VOTES</b>		<i>Min</i>	<i>Max</i>	<i>Avg</i>	<i>Var</i>
LIMBO ( $\phi = 1.0$ )	<i>IL</i>	71.98	73.29	72.55	0.083
	<i>CU</i>	2.83	2.94	2.89	0.0006
LIMBO ( $S = 128KB$ )	<i>IL</i>	71.98	73.68	72.54	0.08
	<i>CU</i>	2.80	2.93	2.89	0.0007
COOLCAT ( $s = 435$ )	<i>IL</i>	71.99	95.31	73.55	12.25
	<i>CU</i>	0.19	2.94	2.78	0.15
<b>MUSHROOM</b>		<i>Min</i>	<i>Max</i>	<i>Avg</i>	<i>Var</i>
LIMBO ( $\phi = 1.0$ )	<i>IL</i>	81.45	81.45	81.45	0.00
	<i>CU</i>	1.71	1.71	1.71	0.00
LIMBO ( $S = 1024KB$ )	<i>IL</i>	81.46	81.46	81.46	0.00
	<i>CU</i>	1.71	1.71	1.71	0.00
COOLCAT ( $s = 1000$ )	<i>IL</i>	81.60	87.07	84.57	3.50
	<i>CU</i>	0.80	1.73	1.46	0.05

Table 9: Statistics for IL(%) and CU

sample size was 1,000 for all runs. Table 9 indicates that LIMBO behaves in a more stable fashion over different runs (that is, different input orders). Notably, for the Mushroom data set, LIMBO’s performance is exactly the same in all runs, while for Votes it exhibits a very low variance. This indicates that LIMBO is not particularly sensitive to the input order of data.

The performance of COOLCAT appears to be sensitive to the following factors: the choice of representatives, the sample size, and the ordering of the tuples. After detailed examination we found that the runs with maximum information loss for the Votes data set correspond to cases where an outlier was selected as the initial representative. The Votes data set contains three such tuples, which are far from all other tuples, and they are naturally picked as representatives.<sup>7</sup> Reducing the sample size, decreases the probability of selecting outliers as representatives, however it increases the probability of missing one of the clusters. In this case, high information loss may occur if

<sup>7</sup>A very recent version of COOLCAT includes a step designed to avoid such selections [1]. We plan to implement this step for future experiments.

<i>Sample Size = Leaf Entries = 384</i>					
<b>Algorithm</b>	<i>IL(%)</i>	<i>P</i>	<i>R</i>	<i>E<sub>min</sub></i>	<i>CU</i>
LIMBO	<b>72.52</b>	<b>0.89</b>	<b>0.87</b>	<b>0.13</b>	<b>2.89</b>
COOLCAT	74.15	0.86	0.84	0.15	2.63
<i>Sample Size = Leaf Entries = 27</i>					
<b>Algorithm</b>	<i>IL(%)</i>	<i>P</i>	<i>R</i>	<i>E<sub>min</sub></i>	<i>CU</i>
LIMBO	<b>72.55</b>	<b>0.89</b>	<b>0.87</b>	<b>0.13</b>	<b>2.89</b>
COOLCAT	73.50	0.88	0.86	0.13	2.87

Table 10: LIMBO vs COOLCAT on Votes

COOLCAT picks as representatives two tuples that are not maximally far apart. Finally, there are cases where the same representatives may produce different results. As tuples are inserted to the clusters, the representatives “move” closer to the inserted tuples, thus making the algorithm sensitive to the ordering of the data set.

In terms of computational complexity both LIMBO and COOLCAT include a stage that requires quadratic complexity. For LIMBO this is Phase 2. For COOLCAT this is the step where all pairwise entropies between the tuples in the sample are computed. We experimented with both algorithms having the same input size for this phase, *i.e.*, we made the sample size of COOLCAT, equal to the number of leaves for LIMBO. Results for the Votes and Mushroom data sets are shown in Tables 10 and 11. LIMBO outperforms COOLCAT in all runs, for all quality measures. The two algorithms are closest in quality for the Votes data set with input size 27, and farthest apart for the Mushroom data set with input size 275. COOLCAT appears to perform better with smaller sample size, while LIMBO remains essentially unaffected.

### 5.5.3 Web Data

Since this data set has no predetermined cluster labels, we use a different evaluation approach. We applied LIMBO with  $\phi = 0.0$  and clustered the authorities into three clusters. (The choice of  $k$  is discussed in detail in Section 6.) The total information loss was 61%. Figure 15 shows the authority to hub table, after permuting the rows so that we group together authorities in the same cluster, and the columns so that each hub is assigned to the cluster to which

<i>Sample Size = Leaf Entries = 275</i>					
<b>Algorithm</b>	<i>IL(%)</i>	<i>P</i>	<i>R</i>	<i>E<sub>min</sub></i>	<i>CU</i>
LIMBO	<b>81.45</b>	<b>0.91</b>	<b>0.89</b>	<b>0.11</b>	<b>1.71</b>
COOLCAT	83.50	0.76	0.73	0.27	1.46
<i>Sample Size = Leaf Entries = 18</i>					
<b>Algorithm</b>	<i>IL(%)</i>	<i>P</i>	<i>R</i>	<i>E<sub>min</sub></i>	<i>CU</i>
LIMBO	<b>81.45</b>	<b>0.91</b>	<b>0.89</b>	<b>0.11</b>	<b>1.71</b>
COOLCAT	82.10	0.82	0.81	0.19	1.60

Table 11: LIMBO vs COOLCAT on Mushroom

it has the most links. LIMBO manages to characterize the structure of the web graph. Authorities are clustered in

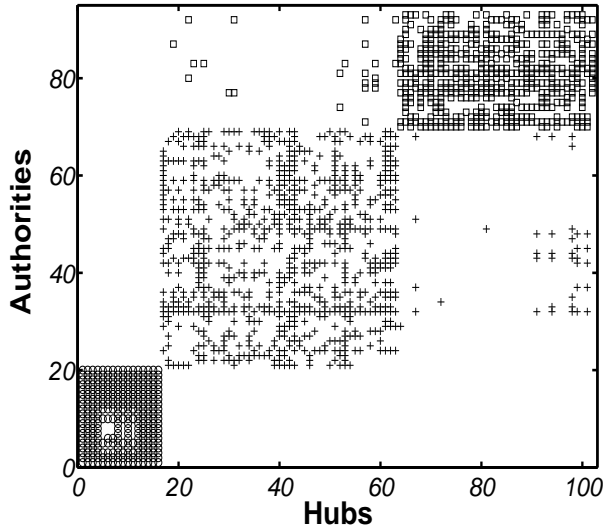

Figure 15: Clustering of Web Data

three distinct clusters, such that the ones in the same cluster share many hubs, while the ones in different clusters have very few hubs in common. The three different clusters correspond to different web communities, and different viewpoints on the issue of abortion. The first cluster consists of “pro-choice” pages. The second cluster consists of “pro-life” pages. The third cluster contains a set of pages from `cincinnati.com` that were included in the data set by the algorithm that collects the web pages, despite having no apparent relation to the abortion query. A complete list of the results can be found in Tables 12, 13 and 14. In almost all cases the URLs and Titles of the web pages

are indicative of their content.

#### 5.5.4 Intra-Attribute Value Clustering

We now present results for the application of LIMBO to the problem of intra-attribute value clustering. For this experiment, we use the Bibliographic data set. We are interested in clustering the conferences and journals, as well as the first authors of the papers. We compare LIMBO with STIRR, an algorithm for clustering attribute values.

Following the description of Section 3.3, for the first experiment we set the random variable  $A'$  to range over the conferences/journals, while variable  $\tilde{A}$  ranges over first and second authors, and the year of publication. There are 1,211 distinct venues in the data set; 815 are database venues, and 396 are theory venues.<sup>8</sup> Results for  $\phi = 1.0$  and  $S = 5MB$  are shown in Table 15. LIMBO's results are superior to those of STIRR with respect to all quality measures. The difference is especially pronounced in the  $P$  and  $R$  measures.

We now turn to the problem of clustering the first authors. Variable  $A'$  ranges over the set of 1,416 distinct first authors in the data set, and variable  $\tilde{A}$  ranges over the rest of the attributes. We produce two clusters, and we evaluate the results of LIMBO and STIRR based on the distribution of the papers that were written by first authors in each cluster. Figures 16 and 17 illustrate the clusters produced by LIMBO and STIRR, respectively. The  $x$ -axis in both figures represents publishing venues while the  $y$ -axis represents first authors. If an author has published a paper in a particular venue, this is represented by a point in each figure. The thick horizontal line separates the clusters of authors, and the thick vertical line distinguishes between theory and database venues. Database venues lie on the left of the line, while theory ones on the right of the line.

From these figures, it is apparent that LIMBO yields a better partition of the authors than STIRR. The upper half corresponds to a set of theory researchers with almost no publications in database venues. The bottom half, corresponds to a set of database researchers with very few publications in theory venues. Our clustering is slightly smudged by the authors between index 400 and 450 that appear to have a number of publications in theory. These are drawn in the database cluster due to their co-authors. STIRR, on the other hand, creates a well separated theory cluster (upper half), but the second cluster contains authors with publications almost equally distributed between theory and database venues.

---

<sup>8</sup>The data set is pre-classified, so class labels are known.

(Pro-Life Cluster) 49 web pages	
URL	Title
http://www.afterabortion.org	After Abortion: Information on the aftereffects of abortion
http://www.lifecall.org	Abortion Absolutely Not! A Several Sources Prolife Website
http://www.lifeinstitute.org	International abortion reports and prolife news
http://www.rtl.org	Information at Right to Life of Michigan's homepage
http://www.silentscream.org	Silent Scream Home Page
http://www.heritagehouse76.com	Empty title field
http://www.peopleforlife.org	Abortion, Life and Choice
http://www.stmichael.org/OCL/OCL.html	Orthodox Christians For Life Resource Page
http://www.worldvillage.com/wv/square/chapel/safehaven	Empty title field
http://www.prolife.com	Pro-Life America
http://www.roevwade.org	RoevWade.org
http://www.nrlc.org	National Right to Life Organization
http://www.hli.org	Human Life International (HLI)
http://www.pregnancycenters.org	Pregnancy Centers Online
http://www.prolife.org/ultimate	Empty title field
http://www.mich.com/buffalo	Catholics United for Life
http://www.prolife.org	Empty title field
http://www.prolife.org/mssl	Empty title field
http://www.pfli.org	Pharmacists for Life International
http://www.rockforlife.org	Rock For Life
http://members.aol.com/nfofl	Empty title field
http://www.serve.com/fem4life	Feminists For Life of America
http://www.cc.org	Welcome to Christian Coalition of America Web site
http://www.cwfa.org	Concerned Women for America (CWA)
http://www.prolifeaction.org	Pro-Life Action League
http://www.ru486.org	The RU-486 Files
http://www.operationrescue.org	End Abortion in America
http://www.orn.org	Operation Rescue National
http://www.priestsforlife.org	Priests for Life Index
http://www.abortionfacts.com	Abortion facts and information, statistics, hotlines and helplines
http://www.prolifeinfo.org	The Ultimate Pro-Life Resource List
http://www.feministsforlife.org	Feminists For Life of America
http://www.marchforlife.org	The March For Life Fund Home Page
http://www.bfl.org	BFL Home Page
http://www.ppl.org	Presbyterians Pro-Life Home
http://www.wels.net/wlfl	WELS Lutherans for Life
http://www.lifeissues.org	Life Issues Institute, Inc.
http://netnow.micron.net/rtli	Right To Life of Idaho, Inc. Home Page
http://www.ohiolife.org	Ohio Right To Life
http://www.wrtl.org	Index
http://www.powerweb.net/dcwrl	Dodge County Right to Life Home Page
http://www.nccn.net/voice	newvoice
http://www.bethany.org	Bethany Christian Services
http://www.prolife.org/LifeAction	Empty title field
http://www.ovnet.com/voltz/prolife.htm	Pirate Pete's Pro-Life page
http://www.prolife.org/cpcs-online	Empty title field
http://www.care-net.org	Empty title field
http://www.frc.org	FAMILY RESEARCH COUNCIL
http://www.ldi.org	Life Dynamics

Table 12: Pro-Life Cluster of the Web data set



<i>(Pro-Choice Cluster) 24 web pages</i>	
URL	Title
<a href="http://www.gynpages.com">http://www.gynpages.com</a>	Abortion Clinics OnLine
<a href="http://www.prochoice.org">http://www.prochoice.org</a>	NAF - The Voice of Abortion Providers
<a href="http://www.cais.com/agm/main">http://www.cais.com/agm/main</a>	The Abortion Rights Activist Home Page
<a href="http://hamp.hampshire.edu/clpp/nnaf">http://hamp.hampshire.edu/clpp/nnaf</a>	National Network of Abortion Funds
<a href="http://www.ncap.com">http://www.ncap.com</a>	National Coalition of Abortion Providers
<a href="http://www.wcla.org">http://www.wcla.org</a>	Welcome to the Westchester Coalition for Legal Abortion
<a href="http://www.repro-activist.org">http://www.repro-activist.org</a>	Abortion Access Project
<a href="http://www.ms4c.org">http://www.ms4c.org</a>	Medical Students for Choice
<a href="http://www.feministcampus.org">http://www.feministcampus.org</a>	Feminist Campus Activism Online: Welcome Center
<a href="http://www.naral.org">http://www.naral.org</a>	NARAL: Abortion and Reproductive Rights: Choice For Women
<a href="http://www.vote-smart.org">http://www.vote-smart.org</a>	Project Vote Smart
<a href="http://www.plannedparenthood.org">http://www.plannedparenthood.org</a>	Planned Parenthood Federation of America
<a href="http://www.rerc.org">http://www.rerc.org</a>	The Religious Coalition for Reproductive Choice
<a href="http://www.naralny.org">http://www.naralny.org</a>	NARAL/NY
<a href="http://www.bodypolitic.org">http://www.bodypolitic.org</a>	Body Politic Net News Home
<a href="http://www.crlp.org">http://www.crlp.org</a>	CRLP - The Center for Reproductive Law and Policy
<a href="http://www.prochoiceresource.org">http://www.prochoiceresource.org</a>	index
<a href="http://www.caral.org">http://www.caral.org</a>	CARAL
<a href="http://www.protectchoice.org">http://www.protectchoice.org</a>	Pro-Choice Public Education Project
<a href="http://www.agi-usa.org">http://www.agi-usa.org</a>	The Alan Guttmacher Institute: Home Page
<a href="http://www.ippf.org">http://www.ippf.org</a>	International Planned Parenthood Federation (IPPF)
<a href="http://www.aclu.org/issues/reproduct/hmrr.html">http://www.aclu.org/issues/reproduct/hmrr.html</a>	Empty title field
<a href="http://www.nationalcenter.org">http://www.nationalcenter.org</a>	The National Center for Public Policy Research
<a href="http://wlo.org">http://wlo.org</a>	Women Leaders Online and Women Organizing for Change

Table 13: Pro-Choice Cluster of the Web data set

<i>('Cincinnati' Cluster) 20 web pages</i>	
URL	Title
<a href="http://cincinnati.com/traffic">http://cincinnati.com/traffic</a>	Traffic Reports: Cincinnati.Com
<a href="http://careerfinder.cincinnati.com">http://careerfinder.cincinnati.com</a>	CareerFinder: Cincinnati.Com
<a href="http://autofinder.cincinnati.com">http://autofinder.cincinnati.com</a>	Cincinnati Post and Enquirer
<a href="http://classifinder.cincinnati.com">http://classifinder.cincinnati.com</a>	Classifieds: Cincinnati.Com
<a href="http://homefinder.cincinnati.com">http://homefinder.cincinnati.com</a>	HomeFinder: Cincinnati.Com
<a href="http://cincinnati.com/freetime">http://cincinnati.com/freetime</a>	Cincinnati Entertainment: Cincinnati.Com
<a href="http://cincinnati.com/freetime/movies">http://cincinnati.com/freetime/movies</a>	Movies: Cincinnati.Com
<a href="http://cincinnati.com/freetime/dining">http://cincinnati.com/freetime/dining</a>	Dining: Cincinnati.Com
<a href="http://cincinnati.com/freetime/calendars">http://cincinnati.com/freetime/calendars</a>	Calendars: Cincinnati.Com
<a href="http://cincinnati.com">http://cincinnati.com</a>	Cincinnati.Com
<a href="http://cincinnati.com/helpdesk">http://cincinnati.com/helpdesk</a>	HelpDesk: Cincinnati.Com
<a href="http://cincinnati.com/helpdesk/feedback">http://cincinnati.com/helpdesk/feedback</a>	HelpDesk: Cincinnati.Com
<a href="http://cincinnati.com/helpdesk/circulation/circulation.html">http://cincinnati.com/helpdesk/circulation/circulation.html</a>	HelpDesk: Cincinnati.Com
<a href="http://cincinnati.com/helpdesk/circulation/subscribe.html">http://cincinnati.com/helpdesk/circulation/subscribe.html</a>	HelpDesk: Cincinnati.Com
<a href="http://cincinnati.com/search">http://cincinnati.com/search</a>	Search our site: Cincinnati.Com
<a href="http://mall.cincinnati.com">http://mall.cincinnati.com</a>	Cincinnati.Com Advertiser Index
<a href="http://cincinnati.com/advertise">http://cincinnati.com/advertise</a>	The Daily Fix: Cincinnati.Com
<a href="http://cincinnati.com/helpdesk/classifieds">http://cincinnati.com/helpdesk/classifieds</a>	HelpDesk: Cincinnati.Com
<a href="http://cincinnati.com/copyright">http://cincinnati.com/copyright</a>	Cincinnati.Com - Your Key to the City
<a href="http://www.gannett.com">http://www.gannett.com</a>	Gannett home page

Table 14: 'Cincinnati' Cluster of the Web data set

Algorithm	Leaves	IL(%)	P	R	$E_{min}$
LIMBO ( $\phi = 1.0$ )	47	<b>94.01</b>	<b>0.90</b>	<b>0.90</b>	<b>0.11</b>
LIMBO ( $S = 5MB$ )	16	<b>94.02</b>	<b>0.90</b>	<b>0.89</b>	<b>0.12</b>
STIRR	-	98.01	0.56	0.55	0.45

Table 15: Bib clustering using LIMBO & STIRR

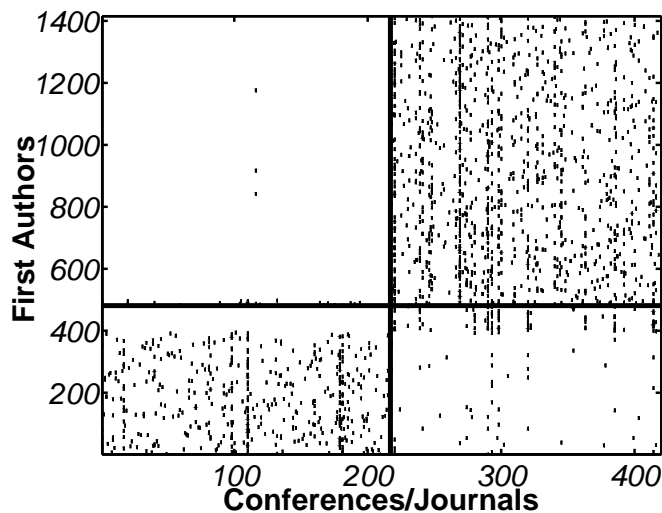

Figure 16: LIMBO clusters of first authors

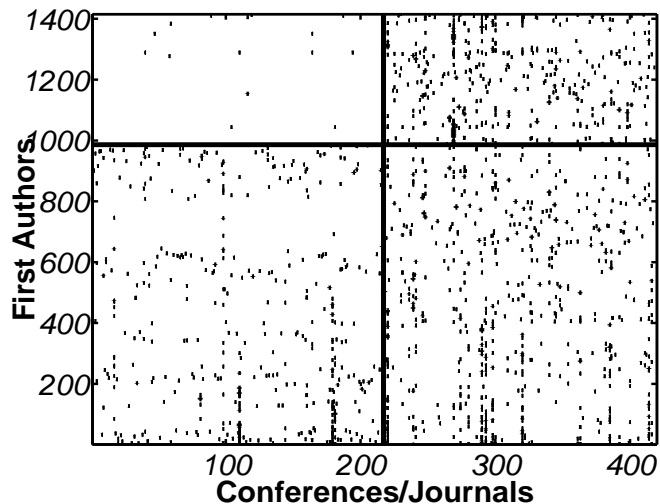

Figure 17: STIRR clusters of first authors

## 5.6 Scalability Evaluation

In this section, we study the scalability of LIMBO algorithm, and we investigate how the parameters of LIMBO affect the execution time. We study the execution time of both  $LIMBO_{\phi}$  and  $LIMBO_S$ . We consider four data sets of size  $500K$ ,  $1M$ ,  $5M$ , and  $10M$ , each containing 10 clusters and 10 attributes with 20 to 40 values each. The first three data sets are samples of the  $10M$  data set.

For  $LIMBO_S$ , the size and the number of leaf entries of the  $DCF$  tree, at the end of Phase 1 is controlled by the parameter  $S$ . For  $LIMBO_{\phi}$  we study Phase 1 in detail. As we vary  $\phi$ , Figure 18 demonstrates that the execution time for Phase 1 decreases at a steady rate for values of  $\phi$  up to 1.0. For  $1.0 < \phi < 1.5$ , execution time drops significantly. This decrease is due to the reduced number of splits and the decrease in the  $DCF$  tree size. In the same plot, we show some indicative sizes of the tree demonstrating that the vectors that we maintain remain relatively sparse. The average density of the  $DCF$  tree vectors, *i.e.*, the average fraction of non-zero entries remains between

41% and 87%. Figure 19 plots the number of leaves as a function of  $\phi$ .<sup>9</sup> We observe that for the same range of values for  $\phi$  ( $1.0 < \phi < 1.5$ ), LIMBO produces a manageable *DCF* tree, with a small number of leaves, leading to fast execution time in Phase 2. Furthermore, in all our experiments the height of the tree was never more than 11, and the occupancy of the tree, *i.e.*, the number of occupied entries over the total possible number of entries, was always above 85.7%, indicating that the memory space was well used.

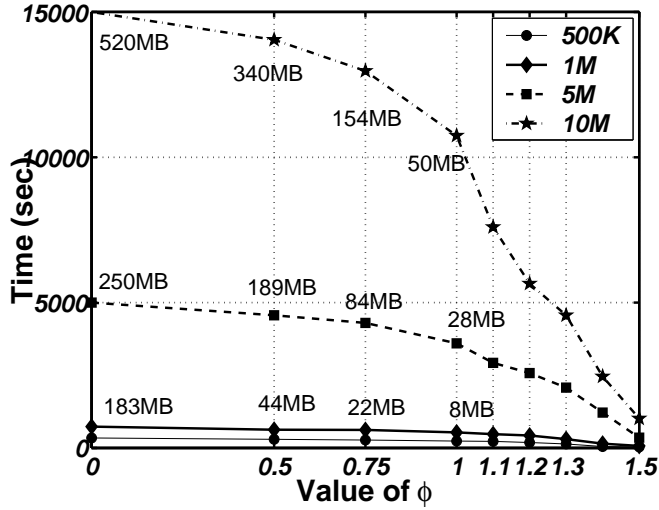

Figure 18: Phase 1 execution times

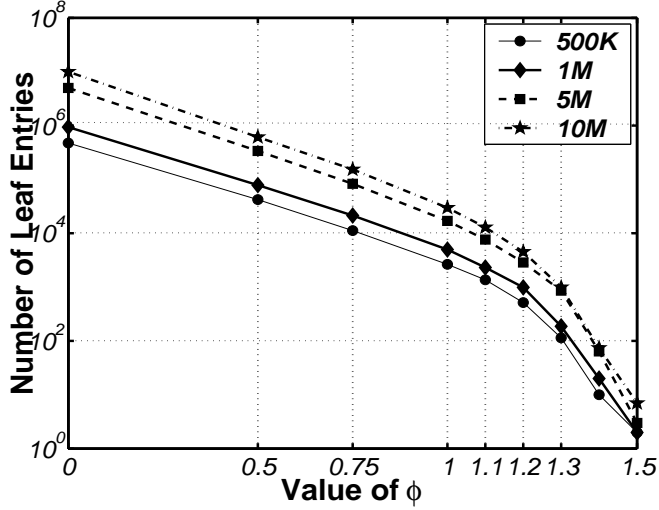

Figure 19: Phase 1 leaf entries

Thus, for  $1.0 < \phi < 1.5$ , we have a *DCF* tree with manageable size, and fast execution time for Phase 1 and 2. For our experiments, we set  $\phi = 1.2$  and  $\phi = 1.3$ . For LIMBO<sub>S</sub> we use buffer sizes of  $S = 1MB$  and  $S = 5MB$ . We now study the total execution time of the algorithm for these parameter values. The graph in Figure 20 shows the execution time for LIMBO <sub>$\phi$</sub>  and LIMBO<sub>S</sub> on the data sets we consider. In this figure, we observe that execution time scales in a linear fashion with respect to the size of the data set for both versions of LIMBO. We also observed that the clustering quality remained unaffected for all values of  $\phi$  and  $S$ , and it was the same *across* the data sets (except for IL in the 1M data set, which differed by 0.01%). Precision ( $P$ ) and Recall ( $R$ ) were 0.999, and the classification error ( $E_{min}$ ) was 0.0013, indicating that LIMBO can produce clusterings of high quality, even for large data sets.

In our next experiment, we varied the number of attributes,  $m$ , in the 5M and 10M data sets and ran both LIMBO <sub>$\phi$</sub> , with  $\phi = 1.2$ , and LIMBO<sub>S</sub>, with a buffer size of 5MB. Figure ?? shows the execution time as a function number of attributes, for different data set sizes. In all cases, execution time increased linearly. Table 16 also presents

<sup>9</sup>The  $y$ -axis of Figure 19 has a logarithmic scale.

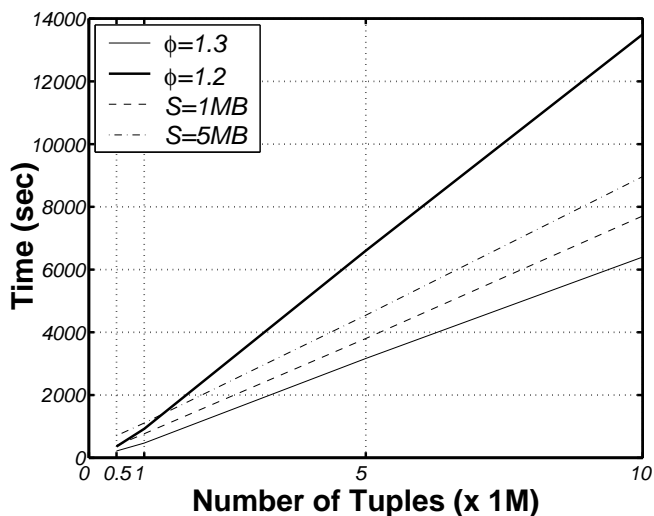

Figure 20: Execution time ( $m=10$ )

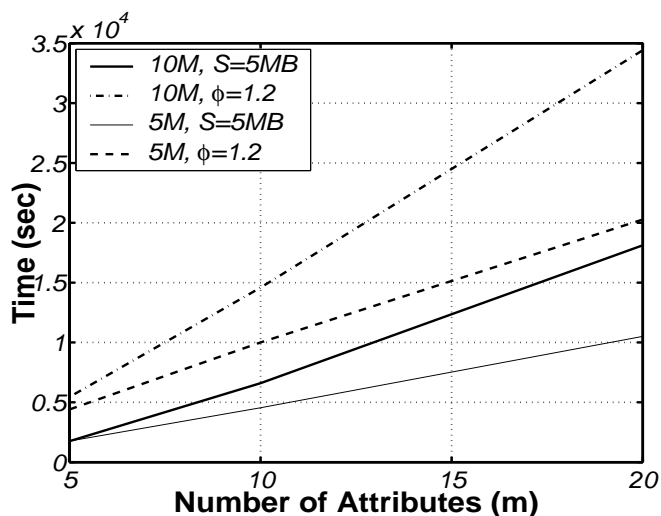

Figure 21: Execution time

$\text{LIMBO}_{\phi,S}$	$IL(\%)$	$P$	$R$	$E_{min}$	$CU$
$m = 5$	49.12	0.991	0.991	0.0013	2.52
$m = 10$	60.79	0.999	0.999	0.0013	3.87
$m = 20$	52.01	0.997	0.994	0.0015	4.56

Table 16:  $\text{LIMBO}_{\phi}$  and  $\text{LIMBO}_S$  quality

the quality results for all values of  $m$  for both LIMBO algorithms. The quality measures are essentially the same for different sizes of the data set.

Finally, we varied the number of clusters from  $k = 10$  up to  $k = 50$  in the  $10M$  data set, for  $\phi = 1.2$  and  $S = 5MB$ . As expected from the analysis of LIMBO in Section 4.4, the number of clusters affected only Phase 3. Recall from Figure 2 in Section 5.4 that Phase 3 is a small fraction of the total execution time. Indeed, as we increase  $k$  from 10 to 50, we observed just 1.1% increase in the execution time for  $\text{LIMBO}_{\phi}$ , and just 2.5% for  $\text{LIMBO}_S$ .

## 6 Estimating $K$

Identifying automatically an appropriate number of clusters in a data set is an important aspect of the clustering problem. In most cases, there is no single correct answer. In this section, we discuss some information-theoretic measures that can be used in hierarchical algorithms to identify the most “natural” clustering sizes for a given data set.

The first measure we consider is the rate of change of mutual information,  $\delta I(A; C_k) = I(A; C_{k+1}) - I(A; C_k)$ . Thinking in reverse,  $\delta I(A; C_k)$  captures the amount of information we gain if we break up a cluster in two, to move from a clustering of size  $k$  to a clustering of size  $k + 1$ . For small values of  $k$ , breaking up the clusters results in large information gains. As  $k$  increases, the information gain decreases. An appropriate value for  $k$  is when the gain  $\delta I(A; C_k)$  becomes sufficiently small. This has also been discussed by Slonim and Tishby [14].

The mutual information  $I(A; C)$  captures the coherence of the clusters, that is, how similar the tuples within each cluster are. For a good clustering, we require that the elements within the clusters be similar, but also that the elements *across* clusters be dissimilar. We capture the dissimilarity across clusters in the conditional entropy  $H(C|A)$ . Intuitively,  $H(C|A)$  captures the *purity* of the clustering. For a clustering  $\mathbf{C}$  with very low  $H(C|A)$ , for each cluster  $c$  in  $\mathbf{C}$ , there exists a set of attribute values that appear almost exclusively in the tuples of cluster  $c$ . The lower the  $H(C|A)$ , the purer the clusters.  $H(C_k|A)$  is minimized for  $k = 1$ , where  $H(C_k|A) = 0$ . An appropriate value for  $k$  is when  $H(C_k|A)$  is sufficiently low, and  $k > 1$ . Furthermore, the value  $\delta H(C_k|A) = H(C_{k+1}|A) - H(C_k|A)$  gives the increase in purity when merging two clusters to move from a clustering of size  $k + 1$  to one of size  $k$ . High values of  $\delta H(C_k|A)$  mean that the two merged clusters are similar. Low values imply that the two merged clusters that are dissimilar. The latter case suggests  $k + 1$  as a candidate value for the number of clusters.

We propose a combination of these measures, as a way of identifying the appropriate number of clusters. When the number of clusters is not known in advance we run Phase 2 of the LIMBO algorithm up to  $k = 1$ . While we run the AIB algorithm in Phase 2, we keep track of the mutual information  $I(A; C_k)$ , and the conditional entropy  $H(C_k|A)$ . Observing the behavior of these two measures, will hopefully provide us with candidate values for  $k$ , for which we run Phase 3 of LIMBO. Our case is best illustrated with the Web data set. Figure 22 presents the plots for  $H(C_k|A)$ ,  $I(C_k|A)$  (left), and  $\delta H(C_k|A)$ ,  $\delta I(A; C_k)$  (right) for the Web data. From the plots we can conclude that for  $k = 3$ , both  $\delta I(A; C_k)$  and  $H(C_k|A)$  are sufficiently close to zero, which means that the clustering is both pure and informative. This becomes obvious when looking at the clustering of Web data in Figure 15. Note that  $\delta H(C_2|A)$  is very low, which means that producing a 2-clustering will result in merging two dissimilar clusters. Similar curves for the Votes are given in Figure 23 and for the Mushroom data set in Figure 24.

For the Votes data set, the  $\delta I(A; C_k)$  curve clearly suggests  $k = 2$  as the right number of clusters. The  $H(C_k|A)$  measure is not equally informative since it increases steadily for increasing  $k$ . For  $k = 6$ ,  $\delta H(C_k|A)$  takes a value

close to zero. When the AIB algorithm moves from 7 to 6 clusters, it merges two highly dissimilar clusters. This suggests  $k = 7$  as a candidate value for the number of clusters. This value was also examined in the evaluation of the COOLCAT algorithm [1].

For the mushroom data set, the  $\delta I(A; C_k)$  curve does not give a clear indication of what the right number of clusters is. The  $H(C_k|A)$  and  $\delta H(C_k|A)$  curves demonstrate that we have very low improvement in purity when we move from 3 to 2 clusters. In fact, after careful examination of the corresponding curves for the individual attributes, we observed that for some attributes,  $\delta H(C_k|A_i)$  is close, or equal to zero for  $k = 2$ . Therefore, the two clusters that are merged when moving from a 3-clustering to a 2-clustering are completely separated with respect to these attributes. This suggest  $k = 3$  as candidate for the number of clusters. Looking at the clusterings we observed that generating 3 clusters results in breaking up the cluster that contained mostly poisonous mushrooms in the 2-clustering. Interestingly, the class of poisonous mushrooms is the concatenation of two classes: “poisonous” and “not recommended” mushrooms. Therefore,  $k = 3$  is a valid candidate for the clustering size. Another possible number of clusters suggested by the curves is  $k = 8$ .

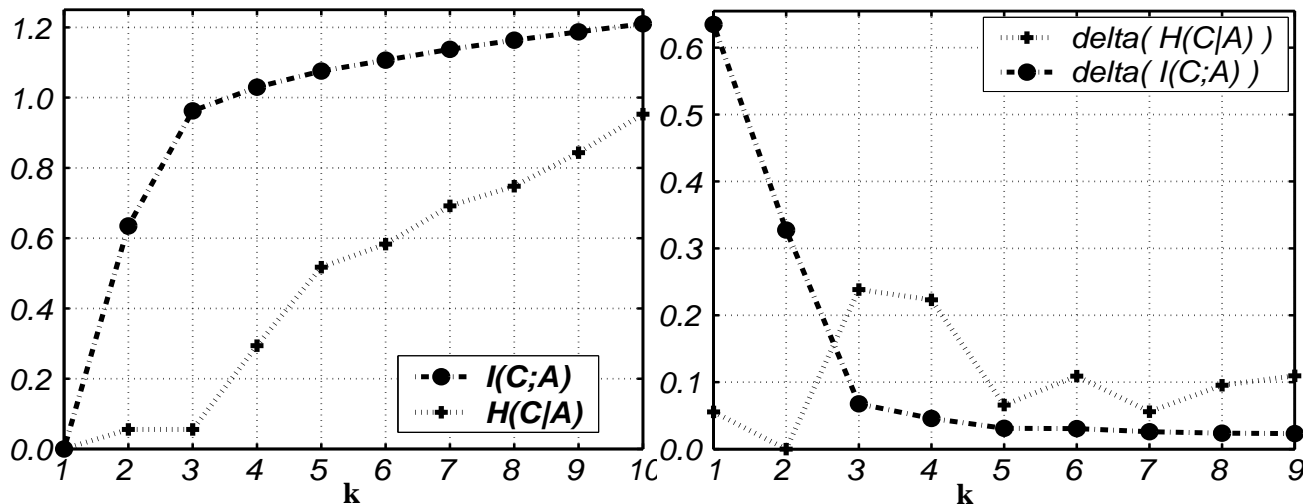

Figure 22:  $I(C; A)$ ,  $H(C|A)$ , and  $\delta I(C; A)$ ,  $\delta H(C|A)$  for Web Data

## 7 Other Related Work

CACTUS, [7], by Ghanti, Gehrke and Ramakrishnan, uses summaries of information constructed from the data set that are sufficient for discovering clusters. The algorithm defines attribute value clusters with overlapping cluster-

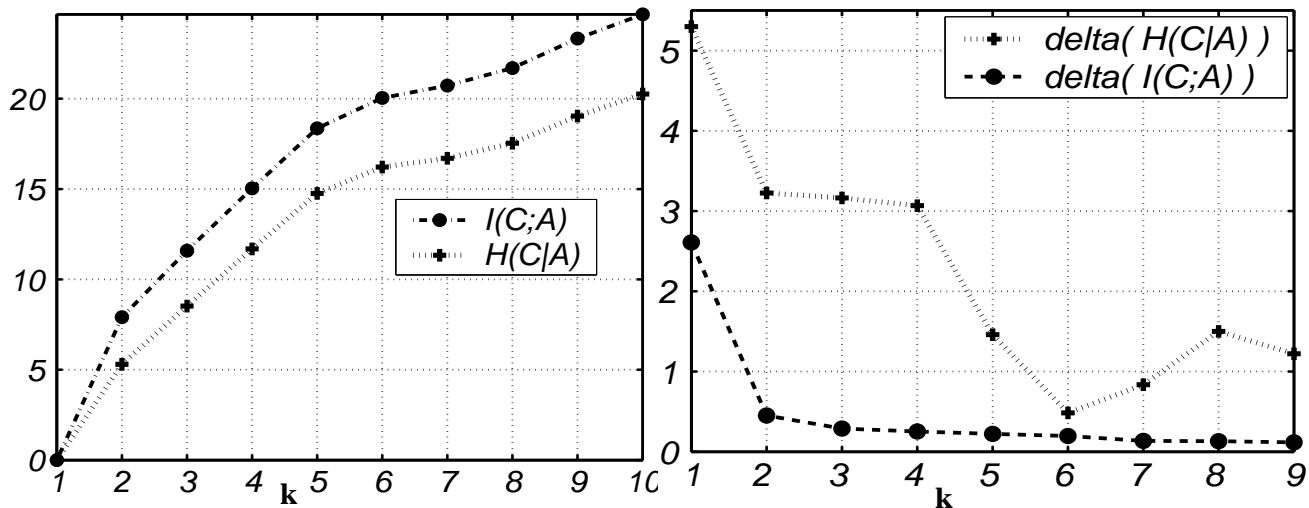

Figure 23:  $I(C;A)$ ,  $H(C|A)$ , and  $\delta I(C;A)$ ,  $\delta H(C|A)$  for Votes

projections on any attribute. This makes the assignment of tuples to clusters unclear.

Our approach is based on the *Information Bottleneck (IB) Method*, introduced by Tishby, Pereira and Bialek [16]. The Information Bottleneck method has been used in an agglomerative hierarchical clustering algorithm [14] and applied to the clustering of documents [15]. Recently, Slonim and Tishby [13] introduced the *sequential Information Bottleneck*, (*sIB*) algorithm, which reduces the running time relative to the agglomerative approach. However, it depends on an initial random partition and requires multiple passes of the data for different initial partitions. In the future, we plan to experiment with sIB in Phase 2 of LIMBO.

Finally, another algorithm that uses an extension to BIRCH [17] is given by Chiu, Fang, Chen, Wand and Jeris [4]. Their approach assumes that the data follows a multivariate normal distribution. The performance of the algorithm has not been tested on categorical data sets.

## 8 Discussion and Future Work

We have evaluated the effectiveness of LIMBO in trading off either quality for time or quality for space to achieve compact, yet accurate, models for small and large categorical data sets. We have shown LIMBO to have advantages over other information theoretic clustering algorithms including AIB (in terms of scalability) and COOLCAT (in terms of clustering quality and parameter stability). We have also shown advantages in quality over other scalable

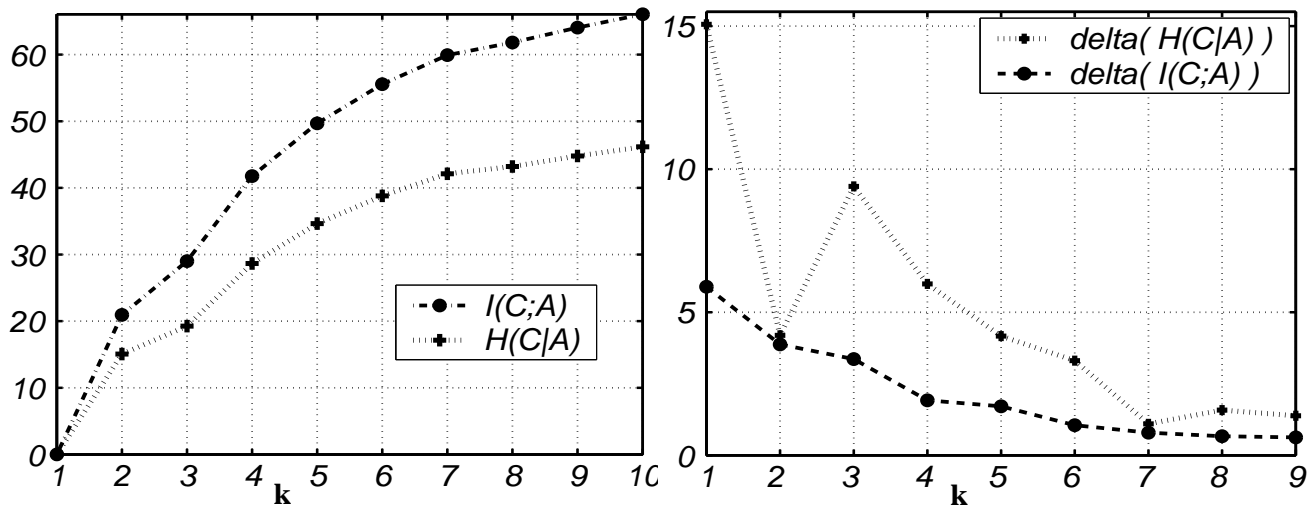

Figure 24:  $I(C;A)$ ,  $H(C|A)$ , and  $\delta I(C;A)$ ,  $\delta H(C|A)$  for Mushroom

and non-scalable algorithms designed to cluster either categorical tuples or values. With our space-bounded version of LIMBO (LIMBO<sub>S</sub>), we can build a model in one pass over the data in a fixed amount of memory while still effectively controlling information loss in the model. These properties make LIMBO<sub>S</sub> amenable for use in clustering streaming categorical data [?] and are properties that have been exploited in recent proposals for clustering streaming numerical data [?]. We are currently evaluating the performance of LIMBO on streaming data. Finally, we plan to apply LIMBO as a data mining technique to schema discovery [?].

## References

- [1] D. Barbará, J. Couto, and Y. Li. An Information Theory Approach to Categorical Clustering. In *Submitted for Publication*.
- [2] D. Barbará, J. Couto, and Y. Li. COOLCAT: An entropy-based algorithm for categorical clustering. In *CIKM*, McLean, VA, 2002.
- [3] A. Borodin, G. O. Roberts, J. S. Rosenthal, and P. Tsaparas. Finding authorities and hubs from link structures on the World Wide Web. In *WWW-10*, Hong Kong, 2001.
- [4] T. Chiu, D. Fang, J. Chen, Y. Wang, and C. Jeris. A Robust and Scalable Clustering Algorithm for Mixed Type Attributes in Large Database Environment. In *KDD*, San Francisco, CA, 2001.
- [5] T. M. Cover and J. A. Thomas. *Elements of Information Theory*. Wiley & Sons, New York, NY, USA, 1991.
- [6] G. Das and H. Mannila. Context-Based Similarity Measures for Categorical Databases. In *PKDD*, Lyon, France, 2000.



- [7] V. Ganti, J. Gehrke, and R. Ramakrishnan. CACTUS: Clustering Categorical Data Using Summaries. In *KDD*, San Diego, CA, 1999.
- [8] M. R. Garey and D. S. Johnson. *Computers and intractability; a guide to the theory of NP-completeness*. W.H. Freeman, 1979.
- [9] D. Gibson, J. M. Kleinberg, and P. Raghavan. Clustering Categorical Data: An Approach Based on Dynamical Systems. In *VLDB*, New York, NY, 1998.
- [10] S. Guha, R. Rastogi, and K. Shim. ROCK: A Robust Clustering Algorithm for Categorical Attributes. In *ICDE*, Sydney, Australia, 1999.
- [11] J. M. Kleinberg. Authoritative Sources in a Hyperlinked Environment. In *SODA*, San Francisco, CA, 1998.
- [12] M. A. Gluck and J. E. Corter. Information, Uncertainty, and the Utility of Categories. In *COGSCI*, Irvine, CA, USA, 1985.
- [13] N. Slonim, N. Friedman, and N. Tishby. Unsupervised Document Classification using Sequential Information Maximization. In *SIGIR*, Tampere, Finland, 2002.
- [14] N. Slonim and N. Tishby. Agglomerative Information Bottleneck. In *NIPS-12*, Breckenridge, CO, 1999.
- [15] N. Slonim and N. Tishby. Document Clustering Using Word Clusters via the Information Bottleneck Method. In *SIGIR*, Athens, Greece, 2000.
- [16] N. Tishby, F. C. Pereira, and W. Bialek. The Information Bottleneck Method. In *37th Annual Allerton Conference on Communication, Control and Computing*, Urban-Champaign, IL, 1999.
- [17] T. Zhang, R. Ramakrishnan, and M. Livny. BIRCH: An efficient Data Clustering Method for Very Large Databases. In *SIGMOD*, Motreal, QB, 1996.